



.....
ST9100A

.....
ST9100AG

.....
AT Interface Drive
.....

.....
Installation Guide
.....

Contents

<i>Read before you begin...</i>	1
Installation overview	2
Setting master/slave jumpers	3
Connecting cables	3
Mounting the drive	5
Configuring system BIOS	5
Formatting and partitioning the drive	8
Installation trouble-shooting	9
Appendix A. AT interface connector pin assignments .	11
Appendix B. Mounting dimensions	12
Appendix C. Technical support services	13

© 1993 Seagate Technology, Inc. All rights reserved
Publication Number: 36217-001, Rev. A

Seagate® Seagate Technology® and the Seagate logo are registered trademarks of Seagate Technology, Inc. SeaFAX™, SeaFONE™, SeaTDD™, and SeaBOARD™ are trademarks of Seagate Technology, Inc. Other product names are trademarks or registered trademarks of their owners.

Seagate reserves the right to change, without notice, product offerings or specifications. No part of this publication may be reproduced in any form without written permission of Seagate Technology, Inc.

Read before you begin...

Note. ST9100A and ST9100AG are usually installed in notebook or laptop systems. Special training or tools may be needed to service these computers. In some instances, opening the case may void your warranty. Be sure to review the terms and conditions of your system warranty before opening the system enclosure.

Warning. To avoid personal injury and damage to the electronic devices, always power off and unplug your computer system before touching any internal components.

Observe static discharge precautions.

- Keep the drive in its static-shielded bag until you are ready to complete the installation.
- Do not touch the PC board or the I/O connector pins.
- Always handle the drive by its edges or frame. Never apply pressure to the PC Board or to the drive top cover.
- Use a grounded wrist strap. If none is available, ground yourself by touching the metal chassis of the system before handling any components.
- Use antistatic padding on all work surfaces and avoid static-inducing carpeted areas.

Check all items. Examine the drive, cables, mounting hardware and accessories, documentation and packaging. If any item is incorrect, missing or appears damaged, contact your distributor or dealer immediately.

Handle drives carefully. Improper handling during transit or shipping accounts for many installation problems. Even minor bumps can exert relatively large G forces on these drives. Always

handle the drive carefully. In addition, do not attach any labels to the drive top cover, as they may prevent proper ventilation.

Warranty. Contact your authorized Seagate distributor or dealer for warranty information.

Maintenance and repair. Seagate drives do not require any preventive maintenance. The head/disc assembly is sealed and does not contain any user-serviceable components. Tampering with the factory seal voids the warranty. Seagate customer-service centers are the only facilities authorized to service Seagate drives. Seagate does not sanction any third-party repair facilities.

Shipping. When transporting or shipping a drive, *you must use* a Seagate-approved container. If possible, use an original Seagate shipping box with a *Seagate Approved Package* label. *Shipping a drive in a nonapproved container voids the drive warranty.*

Seagate service centers may refuse receipt of components improperly packaged or obviously damaged in transit. Call your authorized Seagate distributor to purchase additional boxes. Seagate recommends shipping by an air-ride carrier experienced in handling computer equipment.

Installation overview

Drive installation can be divided into several logical steps:

1. Setting master/slave jumpers
2. Connecting cables
3. Mounting the drive in the system
4. Configuring system BIOS
5. Formatting and partitioning the drive

Each of these steps is described in detail on the following pages. Some may not be applicable to your particular installation requirements.

Setting master/slave jumpers

Two drives may be controlled through a single drive controller cable with two connectors. In this case, one drive is designated as the master and the other is designated as the slave. As shown in Figure 1 on page 4, the jumpers on each drive must be set to identify which drive is master and which is slave.

Connecting cables

ST9100A and ST9100AG drives use a 44-pin AT interface connector cable with two rows of 22 female contacts on 0.079-inch (2 mm) centers (see Figure 1). Pin assignments for the AT interface are listed in Appendix A.

Most cables have a stripe down one side, which designates pin 1. Make sure pin 1 on the interface cable connector is aligned to pin 1 on the drive interface connector and pin 1 on the host connector. To assist in cable alignment, pin 20 has been removed on the male interface connector on the drive. This type of connector is designed to be used with a keyed cable connector having a plug in place of pin 20.

Before mounting the drive, be sure that the connecting cable is long enough to reach the drive, but not so long that it will be pinched when the system enclosure is replaced. Connecting cables for the ST9100A and ST9100AG must be no longer than 18 inches (457 mm).

Power connections

Power for the ST9100A and ST9100AG is supplied through the 44-pin interface connector (see Appendix A for specific pin assignments).

Caution. These drives can accept only +5 volts DC power. Do not use +12 volts DC power.

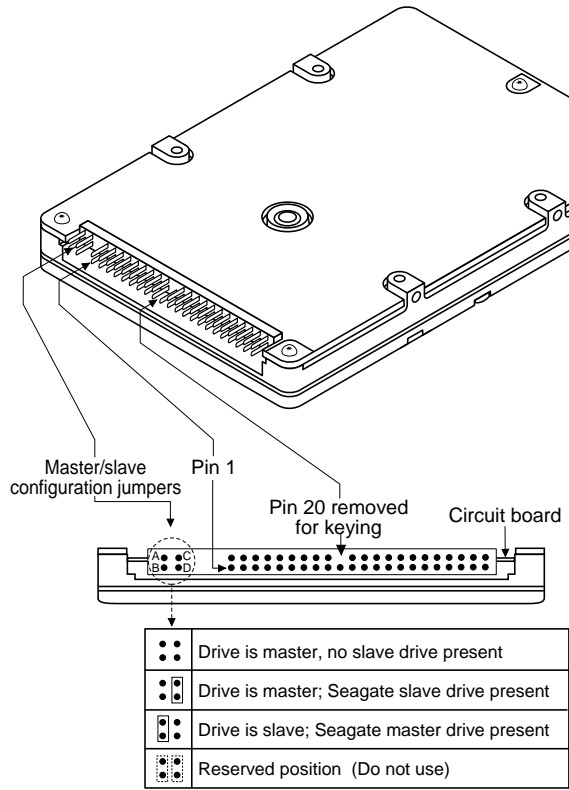

Figure 1. AT interface cable connector and master/slave configuration jumpers

Mounting the drive

You may mount (and operate) the ST9100A and ST9100AG in any orientation. However, you must securely attach the drive to a rigid frame using four side-mounting screws or four bottom-mounting screws.

Caution. To avoid damaging the drive:

- Use M3X0.5 *metric* mounting screws *only*.
- Do not insert mounting screws more than 0.150 inches (3.81 mm) into the mounting holes.
- Do *not* overtighten the screws (maximum torque: 3 inch-lb).

Allow a minimum clearance of 0.030 inches (0.762 mm) around the entire perimeter of the drive for cooling airflow.

Mounting dimension drawings for the ST9100 drives are provided in Appendix B. Most ST9100A and all ST9100AG drives conform to the industry-standard MCC mounting specification. Refer to the *ST9100A and ST9100AG Product Manual* (Seagate Publication 36211-001) for details.

Configuring system BIOS

Before the host system can recognize a new drive, it must be provided with basic information about the drive into the host system BIOS. Specifically, you need to know the number of cylinders, heads, and sectors, as well as the overall capacity of the drive you are installing. The table on page 6 lists these specifications for the ST9100A and ST9100AG. It is not necessary to understand these terms to set up the system BIOS.

Read your system documentation or run your system setup program (described on the following page) to determine which drive types your BIOS supports. Another method is to run the FINDTYPE.EXE utility program, available from Seagate Techni-

cal Support services (on the SeaBOARD BBS) as described in Appendix C.

The methods used to configure system BIOS vary from system to system. In many cases, you can run a setup program from the DOS prompt. In other cases, you must initiate BIOS setup by pressing certain keys while the system is booting up.

Within the setup program, there are three possible ways that you can specify your drive type:

- Match your drive specifications (from the table below) with those of a drive type specified in the setup program.
- Specify a custom or user-defined drive type in the setup program, then manually enter your drive specifications from the table below.
- Select specifications lower than those required for your drive, and allow your drive to mimic the drive type selected.

Drive Specification	ST9100A and ST9100AG
No. cylinders	748
No. read/write heads	14
No. sectors per track	16
Total No. sectors	167,552
Capacity (Mbytes)	
BIOS calculated	81.8
Usable	85.8

When the drive specifications are entered manually as a user-defined or custom drive type, the BIOS should display a drive capacity equal to the *BIOS calculated capacity* in the table above. This value will be lower than the usable drive capacity.

In a few situations, none of the drive types specified in your BIOS setup program will match your drive, and the setup program will not provide an opportunity to specify a custom drive type. In this case, consider the third option described on page 6 — allowing your ST9100A or ST9100AG drive to mimic one of the BIOS-supported drive types. During the BIOS setup process, simply select a drive type with a capacity that is *less than or equal to* the drive's BIOS calculated capacity listed in the table on page 6. This drive type should have no more than 1,024 cylinders, 16 read/write heads, or 63 sectors per track. In addition, the total number of sectors for that drive type (listed in the setup program) should not exceed the number of cylinders times the number of read/write heads times the number of sectors per track. In other words:

$$\text{Total sectors per drive} \leq (\text{No. cylinders}) \times (\text{No. read/write heads}) \times (\text{No. sectors/track})$$

BIOS compatibility recommendations

The ST9100A and ST9100AG are AT interface compatible drives, which conform to ATA specifications. The host system BIOS must provide support for the AT interface command set. Consult the system documentation for information on the AT interface within your system. Several key compatibility issues are discussed below.

In accordance with ATA specifications, the BIOS must reset any emulation/translation parameters after a hard reset is received from the host.

In some configurations, the ST9100A and ST9100AG drives supply 16 bytes of Error Correction Code (ECC) with the Read Long and Write Long commands. Depending on the drive type, your system BIOS may look for 4 bytes of ECC. If your system BIOS expects 4 bytes of ECC and the drive supplies 16 bytes,

some drive diagnostic programs may fail, typically resulting in time-out errors. Consult your system documentation or call your system dealer or manufacturer for information on configuring your system to receive 4 bytes of ECC.

Formatting and partitioning the drive

Caution. Reformatting or repartitioning a drive that contains data may result in a partial or complete loss of that data. Make sure all data has been safely backed up before repartitioning or reformatting a drive. Seagate Technology assumes no liability for lost data.

Low-level formatting

Seagate AT Interface drives are low-level formatted at the factory and do not require additional low-level formatting prior to use.

Partitioning

A single disc drive can be subdivided into partitions that behave as separate drives (labeled C, D, E, etc.). Versions of DOS prior to Version 4.0 are not able to access more than 32 Mbytes of disc space as a single drive. Therefore, drives having a capacity of over 32 Mbytes *must* be divided into several smaller partitions for use with these older versions of DOS. Seagate does not recommend using the ST9100A or ST9100AG with a DOS version prior to Version 3.3.

To partition a drive, you must first boot the system using a floppy disk that contains system files. Partition the drive using the DOS FDISK utility program (described in your DOS manual). If you are partitioning a drive that will be used to boot the system, make sure that the primary DOS partition is marked active.

High-level formatting

Once the drive is partitioned, use the DOS FORMAT command (or equivalent utility program) to high-level format each of the

drive partitions. This process verifies the information written by the low-level format and creates file allocation tables (used to catalog and access files). Consult your DOS manual for FORMAT command options. During formatting, DOS system files should be transferred to one disc partition (generally the "C" drive), so that the system can boot off of that drive. After high-level formatting a drive, you can verify the usable drive capacity using the DOS CHKDSK utility program.

Installation troubleshooting

Before calling Seagate Technical Support, please read and consider all the possibilities discussed below. The suggestions presented here will resolve the vast majority of installation problems.

Warning. To avoid personal injury and damage to electronic components, always power off and unplug the computer system before changing jumpers or touching any internal components.

- **Verify compatibility.** Check the documentation for the host adapter and the drive to confirm that these components are appropriately matched for each other and to your system.
- **Verify your configuration.** Refer to the drive and controller installation guides to make sure all jumper settings suit your configuration requirements.
- **Check all cables.** Make sure all cables are securely connected. Ribbon cables are especially fragile. Make sure they are not crimped or damaged in any way. Having extra cables on hand for troubleshooting saves time and frustration. Most cables have a stripe down one side to designate the pin 1 location. Make sure pin 1 on the interface cable connector is connected to pin 1 on the drive interface connector and pin 1 on the host connector. Refer to Figure 1 on page 4 for the location of pin 1 on the drive interface connector.

- **Check all cards.** Make sure all cards are secured in the expansion slots on the motherboard. Full size (16-bit) cards cannot be plugged into half-size (8-bit) slots. Make sure all cards are plugged into appropriately sized expansion slots. After the cards are permanently installed and the system is running properly, use mounting screws to secure the cards in place.
- **Check the power supply specifications.** The output of your power supply may not be sufficient to meet the power requirements of the new devices you have installed. If you are not sure whether the power supply meets the system requirements, consult your system dealer or distributor.
- **Use the same version of DOS throughout your system.** You must use the same version of DOS throughout all phases of building and configuring your system.
- **Verify the BIOS drive type.** The BIOS drive type you specified during system setup must approximate, but not exceed, the specifications and maximum drive capacity of the drive. Refer to the BIOS configuration section of this manual to double check your drive specifications against those specified in your system BIOS.
- **Check for viruses.** Before installing any new software, scan the installation diskettes for viruses. After the software has been installed on the hard disc, scan that drive for viruses. Symptoms of viruses can include intermittent system lock-ups, reboots and drive errors.

Appendix A. AT interface connector pin assignments

Drive pin #	Signal name	Host pin # and signal description
1	Reset-	1 Host Reset
2	Ground	2 Ground
3	DD7	3 Host Data Bus Bit 7
4	DD8	4 Host Data Bus Bit 8
5	DD6	5 Host Data Bus Bit 6
6	DD9	6 Host Data Bus Bit 9
7	DD5	7 Host Data Bus Bit 5
8	DD10	8 Host Data Bus Bit 10
9	DD4	9 Host Data Bus Bit 4
10	DD11	10 Host Data Bus Bit 11
11	DD3	11 Host Data Bus Bit 3
12	DD12	12 Host Data Bus Bit 12
13	DD2	13 Host Data Bus Bit 2
14	DD13	14 Host Data Bus Bit 13
15	DD1	15 Host Data Bus Bit 1
16	DD14	16 Host Data Bus Bit 14
17	DD0	17 Host Data Bus Bit 0
18	DD15	18 Host Data Bus Bit 15
19	Ground	19 Ground
20	(removed)	20 (No Pin)
21	DMARQ	21 DMA Request
22	Ground	22 Ground
23	DIOW-	23 Host I/O Write
24	Ground	24 Ground
25	DIOR-	25 Host I/O Read
26	Ground	26 Ground
27	IORDY	27 I/O Channel Ready
*28	SPSYNC:CSEL	28 Spindle sync or Cable Select
29	DMACK-	29 DMA Acknowledge
30	Ground	30 Ground
31	INTRQ	31 Host Interrupt Request
32	IOCS16-	32 Host 16 Bit I/O
33	DA1	33 Host Address Bus Bit 1
*34	PDIAG-	34 Passed Diagnostics
35	DA0	35 Host Address Bus Bit 0
36	DA2	36 Host Address Bus Bit 2
37	CS1FX-	37 Host Chip Select 0
38	CS3FX-	38 Host Chip Select 1
*39	DASP-	39 Drive Active/ Drive 1 Present
40	Ground	40 Ground

*Indicates master-slave signals (details shown below).

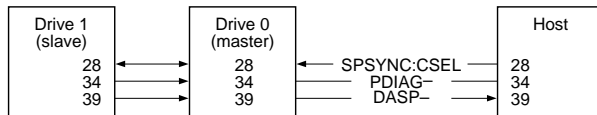

Appendix B. Mounting dimensions

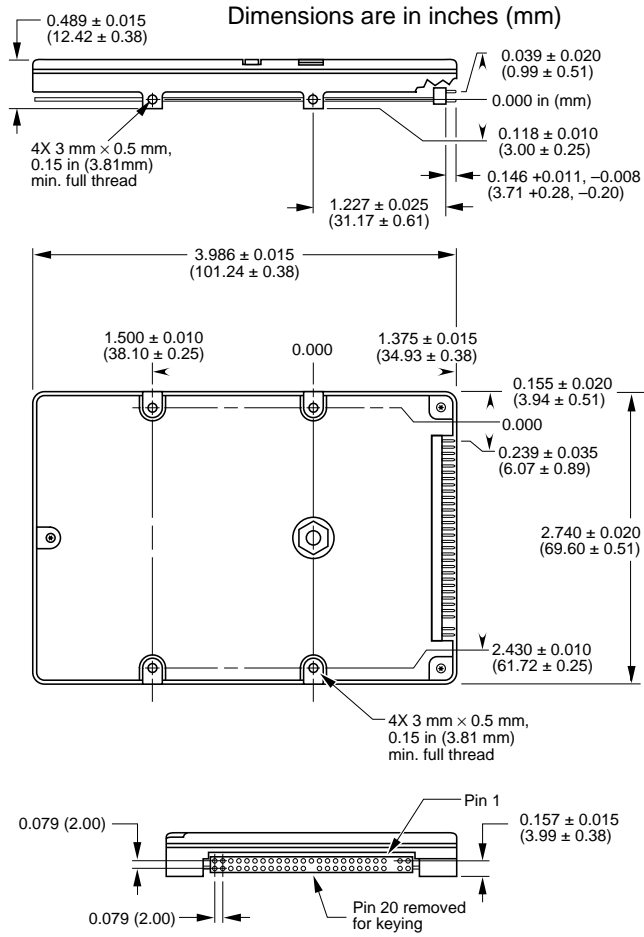

Appendix C.

Technical support services

Product technical support is available for all Seagate products by calling the SeaFAX, SeaFONE, SeaTDD and SeaBOARD services described below. These services are free but long-distance charges (if any) are paid by the user.

SeaFAX. 408/438-2620

You can use a Touch-Tone telephone to access Seagate's automated FAX system and select technical support information by return FAX. This service is available 24 hours a day, 7 days a week.

SeaFONE. 408/438-8222

Seagate's phone system provides recorded technical information on selected Seagate products while you are on hold. Technical support specialists are available to answer questions from 8:00 A.M. to 5:00 P.M. (PST), Monday through Friday. Recordings are accessible 24 hours a day, 7 days a week.

SeaTDD. 408/438-5382

Using a TDD (Telecommunications Device for the Deaf) device, you can send questions or comments 24 hours a day, or communicate with a technical support specialist between 8:00 A.M. and 5:00 P.M. (PST), Monday through Friday.

SeaBOARD

The Seagate Technical Support Bulletin Board System (BBS) is available 24 hours a day, 7 days a week. A modem is required to access this service. Set your communications software for eight data bits, no parity and one stop bit (8N1).

Using the SeaBOARD BBS you can obtain:

- Specifications and configuration for Seagate products.

- Reprints of Seagate documentation.
- A directory of information and helpful utility programs that you can download to your own computer.
- The FINDTYPE.EXE utility program, which can be very useful in drive installation. It compares the drive's geometry with all geometries supported by your system BIOS. This program either signals that an exact match exists between the drive geometry and the system BIOS, or recommends the closest drive type supported by your system BIOS.

BBS location	Modem number	Maximum baud rate
United States	408-438-8771	9600
England	44-62-847-8011	9600
France	33-1-40 67 10 34	9600
Germany	49-89-140-9331	2400
Singapore	65-292-6973	9600
Australia	61-2-756-2359	9600

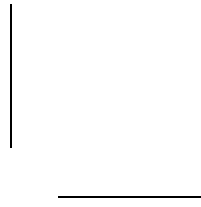
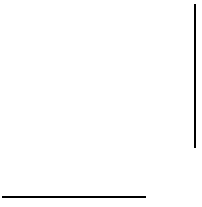

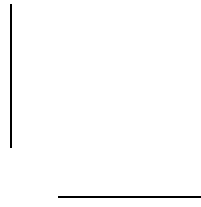
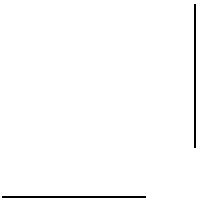

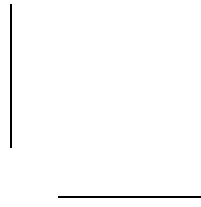
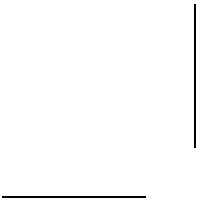



Seagate Technology, Inc.
920 Disc Drive, Scotts Valley, CA 95066, USA

Publication Number: 36217-001, Rev. A, Printed in USA