

How To Use This Manual

In the toolbar:



Previous Page / Next Page



Go to Previous View / Go to Next View



Go to Contents Page / Go to Precautions Page

On the page:

Click on the text within the Contents page to jump to information on that topic.

Printing:

While optimized for onscreen viewing, the pages of this manual are formatted for printing on 8 1/2" x 11" and A4 sized paper, giving you the option to print the entire manual or just a specific page or section.

To Exit:

From the Menu bar at the top of your screen, select: File > Quit.

Icons Used In This Manual

Italicized paragraphs feature an icon describing the type of information being given.



Important Info: *This icon refers to an important step that must be followed.*



Tech Note: *This icon refers to tips to help maximize performance.*



Caution! *This icon indicates a potential hazard, and gives tips on how to avoid them.*

Table of Contents

Foreword	4
Precautions	6
1. Introduction	7
1.1. What Your LaCie Drive Can Do	7
1.2. Hard Drive Heat Management	8
2. Your LaCie Drive	10
2.1. Minimum System Requirements	10
2.2. Package Contents And Views Of The Drive	11
2.2.1. Package Contents	11
2.2.2. Views Of The Drive	12
2.3. Cables And Connectors	14
2.3.1. FireWire	14
2.3.2. USB	15
3. Installing Your LaCie Drive	16
3.1. Connecting The Power Supply	17
3.2. Connecting The Interface Cable	18
3.2.1. Mac Users	18
3.2.2. Windows Users	26
3.3. Connecting Digital Video Cameras To The Drive	31
3.4. Installing Multiple Devices	32
3.5. Disconnecting Your LaCie Drive	33
3.6. Switching Between USB And FireWire Connections	34
4. Using Your LaCie Drive	35
4.1. Formatting And Partitioning Your LaCie Drive	36
4.1.1. Mac Users	36
4.1.2. Windows Users	38
5. Tech Tips	40
5.1. File System Formats	40
5.1.1. Mac Users	40

5.1.2. Windows Users	41
5.2. Available Storage Capacity	42
5.3. Optimizing Data Transfers	42
5.3.1. FireWire 800 Ports And Performance	43
5.3.2. Hi-Speed USB 2.0 Ports And Performance	43
5.4. Hi-Speed USB 2.0 vs. FireWire 400 vs. FireWire 800	44
6. FireWire Questions & Answers	45
7. USB Questions & Answers	47
8. Troubleshooting	49
8.1. Mac Users	50
8.2. Windows Users	53
9. Contacting Customer Support	56
10. Warranty	58
Glossary	59

Copyrights

Copyright © 2005 LaCie. All rights reserved. No part of this publication may be reproduced, stored in a retrieval system, or transmitted in any form or by any means, electronic, mechanical, photocopying, recording or otherwise, without the prior written consent of LaCie.

Trademarks

Apple, Mac, Macintosh and FireWire are registered trademarks of Apple Computer, Inc. Microsoft, Windows 98, Windows 98 SE, Windows 2000, Windows Millennium Edition and Windows XP are registered trademarks of Microsoft Corporation. Sony and iLink are registered trademarks of Sony Electronics. Other trademarks mentioned in this manual are the property of their respective owners.

Changes

The material in this document is for information only and subject to change without notice. While reasonable efforts have been made in the preparation of this document to assure its accuracy, LaCie assumes no liability resulting from errors or omissions in this document, or from the use of the information contained herein. LaCie reserves the right to make changes or revisions in the product design or the product manual without reservation and without obligation to notify any person of such revisions and changes.

FCC Statement:



Caution! Modifications not authorized by the manufacturer may void the user's authority to operate this device.

NOTE: This equipment has been tested and found to comply with the limits for a Class A digital device, pursuant to Part 15 of the FCC Rules. These limits are designed to provide reasonable protection against harmful interference when the equipment is operated in a commercial environment. This equipment generates, uses, and can radiate radio frequency energy and, if not installed and used in accordance with the instruction manual, may cause harmful interference to radio communications. Operation of this equipment in a residential area is likely to cause harmful interference in which case the user will be required to correct the interference at his own expense.

LaCie Big Disk Extreme with Triple Interface



Tested To Comply
With FCC standards

FOR HOME OR OFFICE USE

NOTE: This equipment has been tested and found to comply with the limits for a Class B digital device, pursuant to Part 15 of the FCC Rules. These limits are designed to provide reasonable protection against harmful interference in a residential installation. This equipment generates, uses and can radiate radio frequency energy and, if not installed and used in accordance with the instructions, may cause harmful interference to radio communications. However, there is no guarantee that interference will not occur in a particular installation. If this equipment does cause harmful interference to radio or television reception, which can be determined by turning the equipment off and on, the user is encouraged to try and correct the interference by one or more of the following measures:

- Reorient or relocate the receiving antenna.
- Increase the separation between the equipment and receiver.
- Connect the equipment into an outlet on a circuit different from that to which the receiver is connected.
- Consult the dealer or an experienced radio/TV technician for help.

Canada Compliance Statement

This Class A digital apparatus meets all requirements of the Canadian Interference-Causing Equipment Regulations.

Manufacturer's Declaration for CE Certification

We, LaCie, solemnly declare that this product conforms to the following European standards:

 Class B EN60950, EN55022, EN50082-1, EN61000-3-2

With reference to the following conditions:

73/23/EEC Low Voltage Directive

89/336/EEC EMC Directive



This symbol on the product or on its packaging indicates that this product must not be disposed of with your other household waste. Instead, it is your responsibility to dispose of your waste equipment by handing it over to a designated collection point for the recycling of electrical waste and electronic equipment. The separate collection and recycling of your waste equipment at the time of disposal will help to conserve natural resources and ensure that it is recycled in a manner that protects human health and the environment. For more information about where you can drop off your waste equipment for recycling, please contact your local city office, your household waste disposal service or the shop where you purchased the product.

Health And Safety Precautions

Only qualified persons are authorized to carry out maintenance on this device.

- Read this User's Guide carefully, and follow the correct procedure when setting up the device.
- Do not open your hard drive or attempt to disassemble or modify it. Never insert any metallic object into the drive to avoid any risk of electrical shock, fire, short-circuiting or dangerous emissions. Your hard drive contains no user-serviceable parts. If it appears to be malfunctioning, have it inspected by a qualified LaCie Technical Support representative.
- Never expose your device to rain, or use it near water, or in damp or wet conditions. Never place objects containing liquids on the drive, as they may spill into its openings. Doing so increases the risk of electrical shock, short-circuiting, fire or personal injury.

General Use Precautions:

- Do not expose the hard drive to temperatures outside the range of 5° to 35°C (41°F to 95°F). Doing so may damage the drive or disfigure its casing. Avoid placing your drive near a source of heat or exposing it to sunlight (even through a window). Inversely, placing your drive in an environment that is too cold or humid may damage the unit.
- Always unplug the hard drive from the electrical outlet if there is a risk of lightning or if it will be unused for an extended period of time. Otherwise, there is an increased risk of electrical shock, short-circuiting or fire.
- Use only the power supply shipped with the device.
- Do not use the hard drive near other electrical appliances such as televisions, radios or speakers. Doing so may cause interference which will adversely affect the operation of the other products.
- Do not place the drive near sources of magnetic interference, such as computer displays, televisions or speakers. Magnetic interference can affect the operation and stability of your hard drive.
- Do not place heavy objects on top of the drive or use excessive force on it.
- Never use excessive force on your drive. If you detect a problem, consult the "Troubleshooting" section in this manual.
- Protect your hard drive from excessive exposure to dust during use or storage. Dust can build up inside the device, increasing the risk of damage or malfunction.
- Never use benzene, paint thinners, detergent or other chemical products to clean the outside of the drive. Such products will disfigure and discolor the casing. Instead, use a soft, dry cloth to wipe the device.



Caution! *The drive's warranty may be void as a result of the failure to respect the precautions listed above.*

1. Introduction

Thank you for the purchase of your new LaCie Big Disk Extreme with Triple Interface! This triple interface hard drive system combines compatibility, convenience and a generous storage capacity to help you manage your data. Your LaCie external hard drive system is cross-platform, which enables you to use it on both Macs and PCs; it can be connected via FireWire 800, FireWire, iLink/DV or Hi-Speed USB 2.0 interfaces; and you can customize the format and partitions of your LaCie drive to match your exact needs.

LaCie's Hard Drive is ideally suited for a wide range of high-end, high-traffic environments, including:

- Workstations
- Audio/Video Editing
- Database Management

Engineered to fit seamlessly in to any work environment, the LaCie Big Disk Extreme with Triple Interface can be stood vertically on the LaCie Drive Stand (included), placed in the LaCie Desk Rack (sold separately) or incorporated into standard 19" computer equipment racks with the LaCie Rackmount Kit (sold separately).

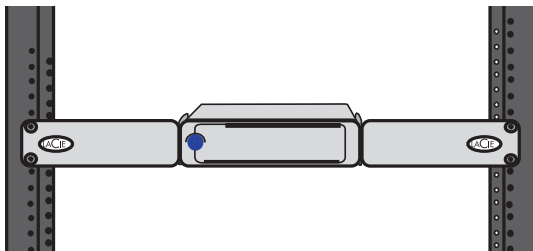
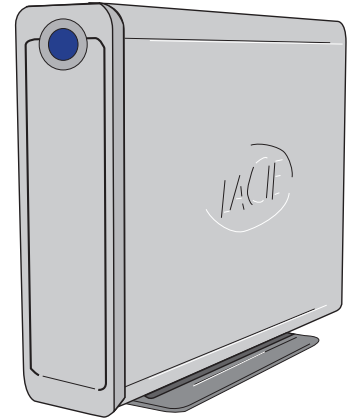

1.1. What Your LaCie Drive Can Do

- Connects to all of the FireWire and USB standard interfaces.
- Back up your computers' internal hard drive.
- Store and exchange data between several computers.
- Daisy-chain FireWire/iLink/DV devices directly to your drive.

1.2 Hard Drive Heat Management

Heat Dissipation Design

The LaCie Big Disk drive's metal body is ideal for naturally dissipating internal drive heat. Its unique design actually draws heat away from the internal drive toward the external casing. The casing absorbs heat and will take advantage of its large surface to further dissipate heat outside the casing. Because of this advantageous feature, heat is taken away from the internal drive, keeping it safe and prolonging its life and reliability. As a consequence, it is normal that the external casing is hot to the touch. Please make sure that the vents of the back-bezel and front-bezel are not obstructed so that there is a natural air-flow across the casing.

To Fan or Not to Fan

The casing alone is a great way to dissipate heat without the need of a fan. Therefore, at the date of this publication, most drives (1 to 3 internal platters*) do not require a fan. Only the largest capacity drives (3 to 5 internal platters*) may need a fan. To find out if your drive includes a fan, please refer to the item number and product datasheet.

Drives Equipped with a Fan

If your LaCie Big or Bigger Disk is equipped with a "smart fan," it will only start when the heat inside the casing reaches a certain temperature. Then the smart fan starts to turn at a low and very quiet speed. In exceptionally hot conditions (summer heat, stacked configuration, etc.) the fan will detect heat and turn to a second, faster speed. Once the heat inside the casing decreases, the smart fan automatically slows down or stops, allowing for the quietest working environment.

*Indicative information - may vary depending on the internal drive models, manufacturers and technology evolutions.

Upright, Stack & Rackmount Configuration

Heat dissipation is maximized when the drive is in the upright position (1). If you have several LaCie drives stacked on each other, please remember to attach the included rubber feet on the under side of your drives (2). This will allow for some air-flow between your drives so that the heat dissipation can work effectively - especially if your LaCie drive does not include a fan. LaCie does not recommend stacking or racking more than 3 x d2 drives, 2 x Big Disks or 2 x Bigger Disks on top of each other(3) and (4), especially if these drives are turned ON at the same time.

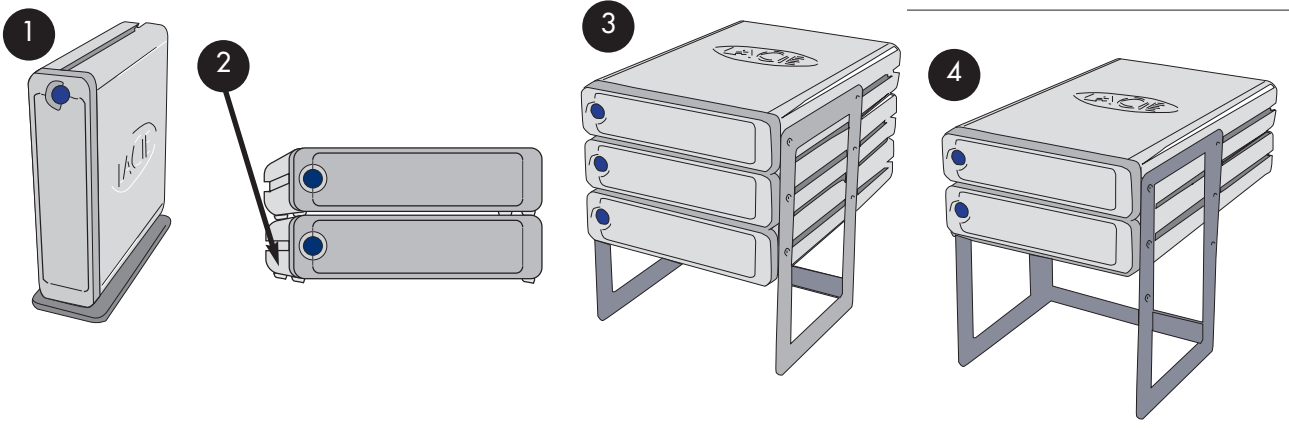

2. Your LaCie Drive

2.1. Minimum System Requirements

Mac Users

FireWire 800

Hardware Requirements for FireWire 800:

- G4 with a FireWire 800/IEEE 1394b interface card

System Requirements for FireWire 800:

- OS 10.2.4 or higher

FireWire

Hardware Requirements for FireWire 400:

- G3 or greater, with FireWire 400/IEEE 1394a interface card

System Requirements for FireWire 400:

- OS 9.x (Apple FireWire support 2.3.3 and greater) and 10.x

Hi-Speed USB 2.0

Hardware Requirements for USB:

- G3 or greater, with USB 2.0 or 1.1 interface card

System Requirements for USB:

- OS 9.x and 10.x (Apple USB support 1.3.5 and greater)

Windows Users

FireWire 800

Hardware Requirements for FireWire 800:

- Pentium III or higher compatible processor, with a FireWire 800/IEEE 1394b interface card

- 128MB RAM or higher

System Requirements for FireWire 800:

- Windows 2000 and Windows XP

FireWire/IEEE 1394/iLink

Hardware Requirements for FireWire 400:

- Pentium II or higher -compatible processor, with a FireWire/IEEE 1394/iLink interface card (SBP-2 compatible) that supports mass storage devices.

- 64MB RAM or greater

System Requirements for FireWire 400:

- Windows 2000 and Windows XP

Hi-Speed USB 2.0

Hardware Requirements for USB:

- Pentium II or higher -compatible processor, with a USB 2.0 or 1.1 interface card

- 32MB RAM or greater

System Requirements for USB:

- Windows 2000 and Windows XP

2.2. Package Contents and Views of the Drive

2.2.1. Package Contents

- 1 LaCie Big Disk Extreme with Triple Interface and Drive Stand kit
- 2 External power supply
- 3 FireWire 800 9-to-9-pin cable
- 4 FireWire 400 6-to-6-pin cable
- 5 iLink/DV 6-to-4-pin cable
- 6 Hi-Speed USB 2.0 cable
- 7 LaCie Storage Utilities CD-ROM

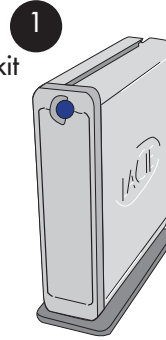

Important Info: Please keep your box. In the event that the drive should need to be repaired or serviced, it must be returned in its original packaging.

2.2.2. Views of the Drive

2.2.2.1. Front View



- 1 On/Off Button / Power LED / Activity LED**
Push the button to power the drive on. The LED remains lit to show that the drive is on, and blinks to indicate drive activity.

2.2.2.2. Back View

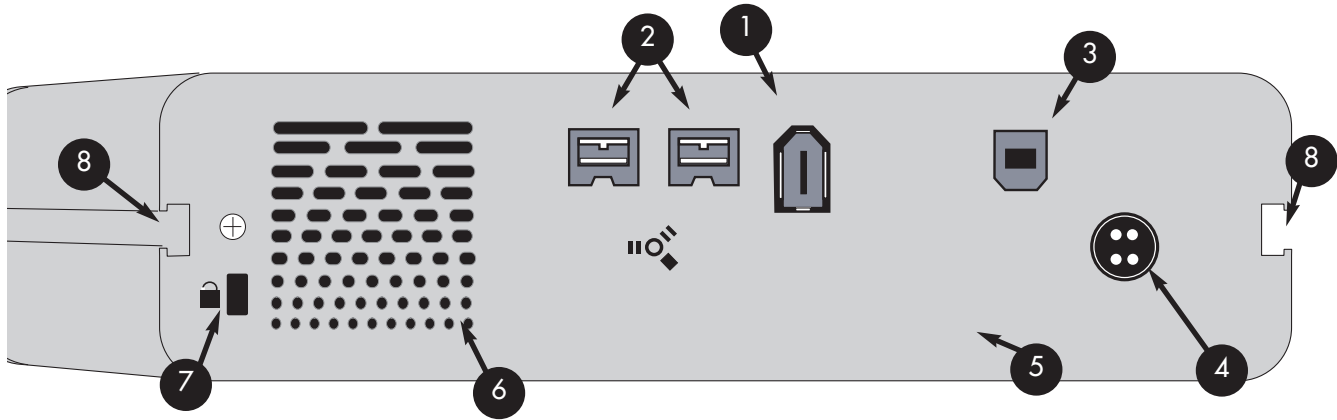

- 1 **FireWire 400 Port** - This is where you plug in the FireWire 400 or iLink/DV cables furnished with the drive. See section [3.2. Connecting the Interface Cable](#) for more information.
- 2 **FireWire 800 Ports** - This is where you plug in the FireWire 800 cable furnished with the drive. See section [3.2. Connecting the Interface Cable](#) for more information.
- 3 **Hi-Speed USB 2.0 Port** - This is where you plug in the Hi-Speed USB 2.0 cable furnished with the drive. See section [3.2. Connecting the Interface Cable](#) for more information.
- 4 **Power Supply Connector** - This is where you plug in the AC adapter supplied with the drive. See section [3.1. Connecting The Power Supply](#) for more information.
- 5 **Serial Number Sticker** - This is where you will find your LaCie drive's serial number. Write down the serial number and keep it in a safe place, because you will need to provide the number in the event you have to call LaCie Technical Support for any reason in regards to the drive's performance. The serial number would also come in handy if your drive is lost or stolen.
- 6 **Ventilation Outlet** - These holes help to keep your drive cool during operation. Be sure not to block these openings when using your drive.
- 7 **Lock Slot** - This slot is used to connect an anti-theft system, such as the LaCie Security Lock, for maximum protection. Refer to your anti-theft system documentation for details on how to connect the lock.
- 8 **Rackmount Grooves** - These grooves are used for attaching your drive to the Drive Stand, mounting in the Desk Rack kit (sold separately) or placing your drive in standard 19" computer equipment racks using the LaCie Rackmount Kit (sold separately).

2.3. Cables and Connectors

2.3.1. FireWire

FireWire 400, also known as IEEE 1394, is a high-speed serial input/output technology for connecting peripheral devices to a computer or to each other, and FireWire 800 is the implementation of the new IEEE 1394b standard.

Pushing the speed barrier to new limits, FireWire 800 offers increased bandwidth and extended cabling distance between devices. FireWire 800 is ideal for bandwidth-intensive applications, such as audio, video and graphics. Benefits of FireWire 800 include:

- Resourceful architecture: FireWire 800 reduces delays in arbitration and signal distortion, and increases throughput.
- Backwards compatibility: adapter cables allow FireWire 400 devices to operate under the FireWire 800 port.

FireWire 400 and FireWire 800 also share the following features:

- Hot-pluggable: devices can be added and removed while the bus is active.
- Isochronous data delivery: no dropped frames – FireWire supports real-time data delivery.
- Flexible: up to 63 devices can be connected on a single bus.

Please see [FireWire Questions And Answers](#) for a more detailed discussion of FireWire's uses and capabilities.

FireWire Icons

These icons will help you easily identify the FireWire interface. They appear on FireWire cables, and next to the FireWire port connectors on certain computers.



FireWire icon



iLink icon



DV icon

FireWire Cables

There are two categories of FireWire cables on the market: FireWire 800 cables, which feature the 9-to-9-pin, 9-to-6-pin, and 9-to-4-pin cables; and the original FireWire cables which feature the 6-to-6-pin and 6-to-4-pin cables.



9-to-9-pin cable: Connects FireWire 800 devices to FireWire 800 ports.



6-to-6-pin cable: Connects FireWire 400 devices to FireWire 400 ports.



6-to-4-pin cable: Connects FireWire 400 devices to iLink/DV ports.

2.3.2. USB

USB is a serial input/output technology for connecting peripheral devices to a computer or to each other. Hi-Speed USB 2.0 is the latest implementation of this standard, and it provides the necessary bandwidth and data transfer rates to support high-speed devices such as hard drives, CD/DVD drives and digital cameras.

Benefits of the USB standard include:

- Backwards compatibility: Hi-Speed USB 2.0 works with the original USB specifications.
- Hot-swappable: no need to shut down or restart your computer when adding or removing devices.

Please see [USB Questions And Answers](#) for a more detailed discussion of USB's uses and capabilities.

USB Icons

These icons will help you easily identify the USB interfaces. They appear on USB cables and next to the USB port connectors on certain computers.



USB 1.1 icon



USB 2.0 icon

USB Cables

Your LaCie drive is shipped with a Hi-Speed USB 2.0 cable, to ensure maximum data transfer performance when connected to a Hi-Speed USB 2.0 port. The cable will also work when connected to a USB port, but drive performance will be limited to USB 1.1 transfer rates.



Hi-Speed USB 2.0 2.0 cable: Connects USB devices to USB ports.

3. Installing Your LaCie Drive

Getting your LaCie drive installed and connected is very simple; essentially there are two steps: 1) connect the power supply to the drive and to an outlet, and 2) connecting an interface cable to the drive and to your computer.

Thanks to its support of three different interfaces and its support of both the Mac and Windows operating system, the LaCie Big Disk Extreme with Triple Interface gives you several different connectivity options. These steps are divided into sections by operating system (Mac or Windows) and the type of interface cable (FireWire 800, FireWire 400, iLink and Hi-Speed USB 2.0).

This chapter also has helpful information about connecting digital video cameras to the LaCie drive, connecting multiple devices and special steps that need to be followed when disconnecting the drive or switching between the different interfaces.

To get started, go to section [3.1. Connecting The Power Supply](#).



Caution! *The LaCie Big Disk Extreme with Triple Interface utilizes the aluminum alloy casing to help dissipate heat. There are important location consideration precautions to keep in mind when setting up your drive. Make sure to place your drive in a well ventilated space, do not block the ventilation outlet on the back of the drive and keep the area in front of the drive unobstructed to allow for proper airflow. If you will be stacking or racking your drive, please follow these considerations:*

- *When stacking drives, place no more than three drives on top of each other.*
- *When stacking drives, make sure and adhere the rubber feet to the bottom of the drives.*
- *When racking drives in the LaCie Desk Rack (sold separately), place no more than three drives in the rack.*
- *When racking in 19" equipment racks, only rack the equipment in a regulated, air-conditioned room, keep cables and other obstructions away from the rear of the drive and do not place more than three drives on top of each other.*

3.1. Connecting the Power Supply

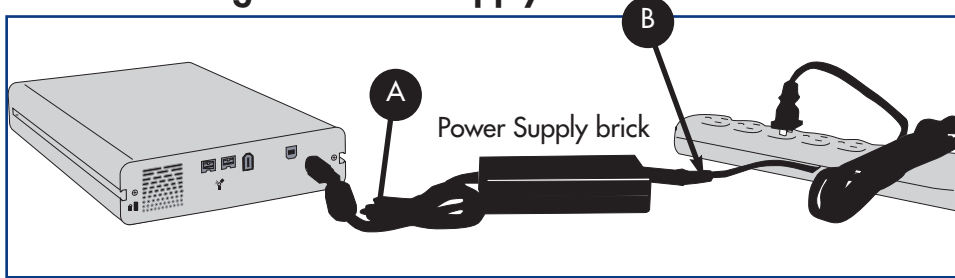

There are two cables that are supplied with the power supply: one cable (A) connects to the LaCie drive; and the other cable (B) connects to a power outlet, such as a wall outlet or a surge protector.

- 1 Connect Cable A to your LaCie Drive.
- 2 Connect Cable B to the Power Supply brick.
- 3 Connect Cable B to a surge protector or wall outlet.

Step 2)



You are now ready to connect the interface cable to your drive and to your computer.



Caution!

- Only use the AC adapter supplied with your specific LaCie drive. Do not use a power supply from another LaCie drive or another manufacturer. Using any other power cable or power supply may cause damage to the device and void your warranty.
- Always remove the AC adapter before transporting your LaCie drive. Failure to remove the adapter may result in damage to your drive and will void your warranty.



Tech Note:

- Your LaCie Big Disk Extreme with Triple Interface comes with an autoswitching power supply. This means that if the drive is connected to a FireWire connector on your computer, when you turn on the computer, the LaCie drive will turn on automatically. Likewise, when you turn off your computer, your LaCie drive will turn off automatically. To turn the drive off, simply push the blue On/Off button on the front of the drive. Do not turn the drive off, though, when it is reading or writing information!
- The LaCie Big Disk Extreme with Triple Interface also manages power consumption. If the system's power save feature supports it, the drive will spin down during the power save mode. After the system comes out of power save, the drive will take a few seconds to spin up to full power before it can be accessed.
- You may use your LaCie drive when in a foreign country, thanks to its autoswitching 100-240 Volt power supply. To be able to use this feature, you may need to purchase an appropriate adapter or cord. Consult LaCie Technical Support for assistance in choosing the right adapter. LaCie accepts no responsibility for any damage to the drive resulting from the use of an inappropriate adapter. Using an adapter other than one authorized by LaCie will void your warranty.

3.2. Connecting the Interface Cable

There are three interface connectivity options when connecting your LaCie Big Disk Extreme with Triple Interface to your computer: FireWire 800, FireWire 400 and Hi-Speed USB 2.0. The installation steps below follow the connectivity options for each of the specific interfaces, depending on your operating system.



Important Info: Windows Users! Move to section [3.2.2. Windows Users](#) to view installation steps for the Windows OS.

3.2.1. Mac Users

These installation steps are separated by interface and Mac OS. To view the installation steps of the interface you plan on using, click on the appropriate operating system and interface:

[Mac OS 10.x – FireWire 800](#)

[Mac OS 10.x – FireWire 400](#)

[Mac OS 9.x – FireWire 400](#)

[Mac OS 10.x – Hi-Speed USB 2.0](#)

[Mac OS 9.x – USB](#)



Important Info: You can not have the FireWire and USB interfaces connected at the same time! If you will be switching between interfaces, you must also follow the steps in section [3.6. Switching Interfaces](#).



Tech Note: To daisy-chain devices, you must be using the same interface FireWire. Your computer will not recognize the daisy-chained device if the interfaces are mixed, i.e. a FireWire device attached to a drive that is connected to the computer via the Hi-Speed USB 2.0 interface.

Daisy-chain configurations:

- FireWire 400 device connected directly to the LaCie Big Disk Extreme with Triple Interface, which is connected to the computer via the FireWire 800 port.
- iLink/DV device connected directly to the LaCie Big Disk Extreme with Triple Interface, which is connected to the computer via the FireWire 800 port.
- FireWire 800 device connected directly to the LaCie Big Disk Extreme with Triple Interface, which is connected to the computer via the FireWire 800 port.



Tech Note: If you will be using your LaCie drive in a cross-platform (Mac/Windows) environment, it is recommended that you re-format the drive to the MS-DOS (also known as FAT 32) File System format. Please see section [5.1. File System Formats](#) for more information.

Mac OS 10.x – FireWire 800

1 After following the steps in [3.1. Connecting The Power Supply](#), power on the drive by pressing the On/Off button on the front of the drive.

2 Connect the 9-pin end of the FireWire 800 cable into the FireWire 800 port on the back of the LaCie Big Disk Extreme with Triple Interface.

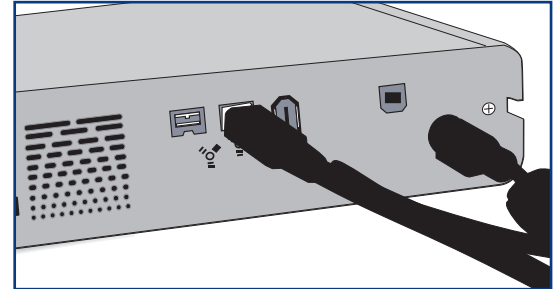

3 Connect the other end of the 9-pin FireWire 800 cable into an available FireWire 800 port on your computer.

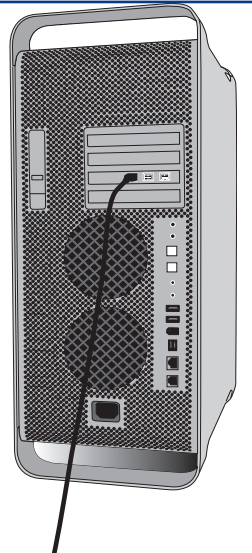

Tech Note: For more information about FireWire, please see sections:

- [2.3.1. FireWire](#)
- [5.3. Optimizing Data Transfers](#)
- [6. FireWire Questions & Answers.](#)

4 Your drive should appear on your desktop. It may take a few seconds for your computer to recognize the drive and for it to appear on the desktop.



Mac OS Drive Icons

Your LaCie Big Disk Extreme with Triple Interface will now be ready for use. You can then use the formatting and partitioning capabilities in the Apple Disk Utility to configure your hard drive system. Please refer to [4.1. Formatting And Partitioning Your LaCie Drive – 4.1.1. Mac Users](#) for more information.

Mac OS 10.x – FireWire 400

- 1 After following the steps in [3.1. Connecting The Power Supply](#), power on the drive by pressing the On/Off button on the front of the drive.
- 2 Connect the 6-pin end of the FireWire 400 cable into the FireWire 400 port on the back of the LaCie Big Disk Extreme with Triple Interface.

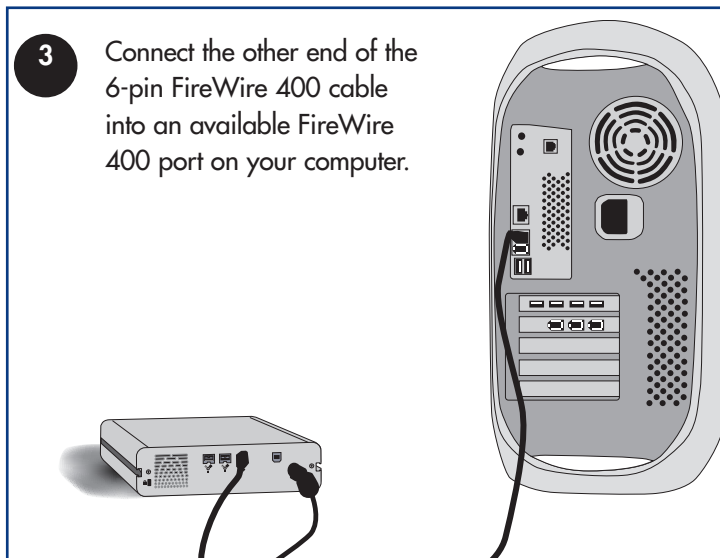
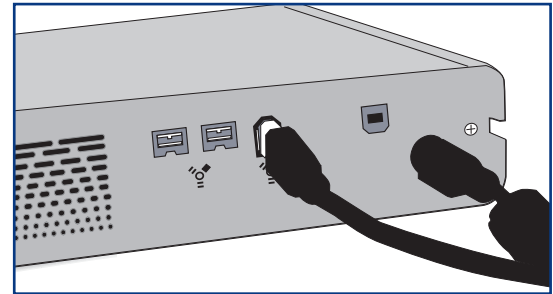

- 3 Connect the other end of the 6-pin FireWire 400 cable into an available FireWire 400 port on your computer.



Tech Note: For more information about FireWire, please see sections:

- [2.3.1. FireWire](#)
- [5.3. Optimizing Data Transfers](#)
- [6. FireWire Questions & Answers.](#)

- 4 Your drive should appear on your desktop. It may take a few seconds for your computer to recognize the drive and for it to appear on the desktop.



Mac OS Drive Icons

Your LaCie Big Disk Extreme with Triple Interface will now be ready for use. You can then use the formatting and partitioning capabilities in the Apple Disk Utility to configure your hard drive system. Please refer to [4.1. Formatting And Partitioning Your LaCie Drive – 4.1.1. Mac Users](#) for more information.

Mac OS 9.x – FireWire 400

To use your new LaCie Big Disk Extreme with Triple Interface, first install the necessary driver software.

Silverlining Pro Installation

- 1) Insert the LaCie Storage Utilities CD in your computer's internal CD/DVD drive.
- 2) Open the CD icon and double-click on the **Silverlining Installer**.
- 3) The Silverlining Utilities screen appears. Click on **Continue**.
- 4) The **About to Install** screen appears. Read the following information and click on **Continue**.
- 5) The **License Agreement** screen appears. Click on **Agree**.
- 6) The **Installation** screen appears.
- 7) Check the **Silverlining Pro** and **FireWire Support** boxes.
- 8) Click on **Install**.
- 9) A message appears to confirm that the installation was successful.
- 10) Click on **Restart** to use your FireWire peripheral immediately.

Now you are ready to move to the next step, Connecting the Drive to the Computer.

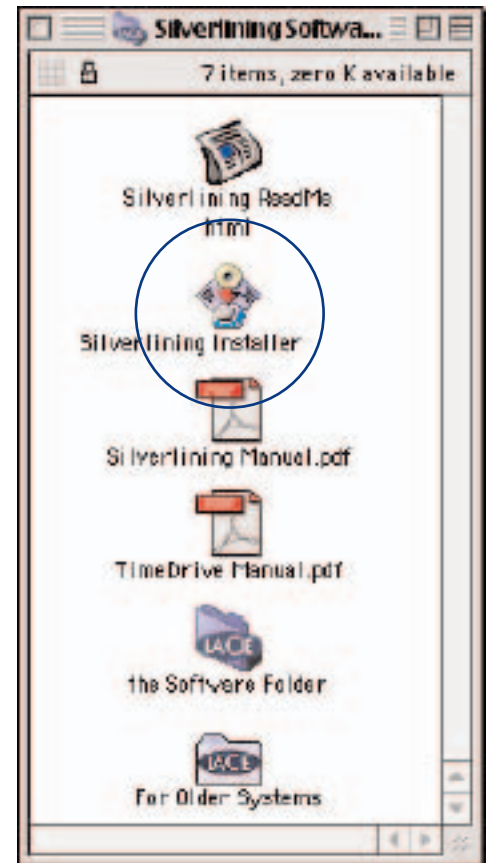

Mac OS 9.x – FireWire 400

Connecting the Drive to the Computer

- 1 After following the steps in [3.1. Connecting The Power Supply](#), power on the drive by pressing the On/Off button on the front of the drive.
- 2 Connect the 6-pin end of the FireWire 400 cable into the FireWire 400 port on the back of the LaCie Big Disk Extreme with Triple Interface.

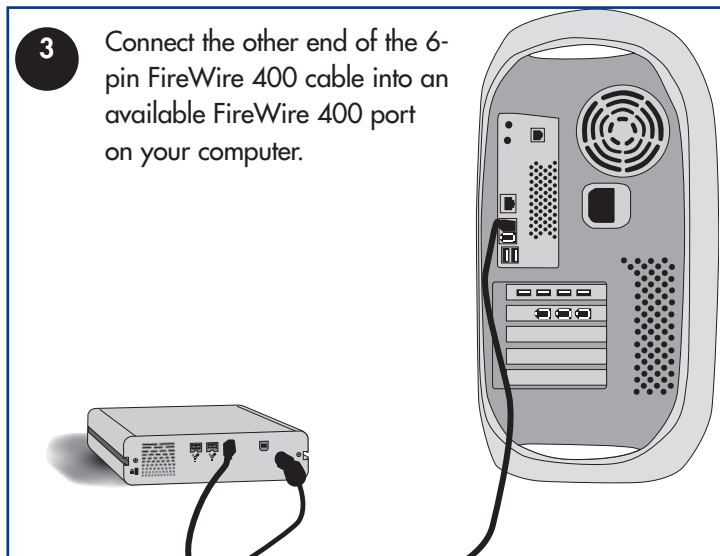
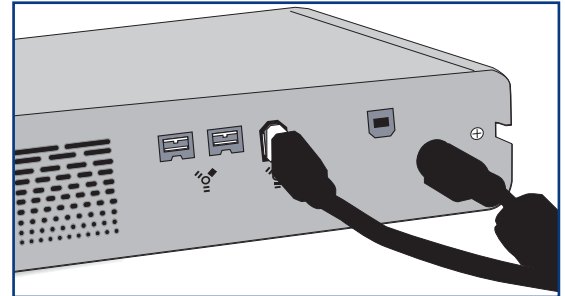

- 3 Connect the other end of the 6-pin FireWire 400 cable into an available FireWire 400 port on your computer.



Tech Note: For more information about FireWire, please see sections:

- [2.3.1. FireWire](#)
- [5.3. Optimizing Data Transfers](#)
- [6. FireWire Questions & Answers.](#)

- 4 Your drive should appear on your desktop. It may take a few seconds for your computer to recognize the drive and for it to appear on the desktop.



Mac OS Drive Icons

Your LaCie Big Disk Extreme with Triple Interface will now be ready for use. You can then use the formatting and partitioning capabilities in **Silverlining Pro** to configure your hard drive system. Please refer to the **Silverlining Pro** documentation on the LaCie Storage Utilities CD-ROM for more information.

Mac OS 10.x – Hi-Speed USB 2.0

- 1 After following the steps in [3.1. Connecting The Power Supply](#), power on the drive by pressing the On/Off button on the front of the drive.
- 2 Connect the Hi-Speed USB 2.0 cable into the Hi-Speed USB 2.0 port on the back of the LaCie Big Disk Extreme with Triple Interface.



Tech Note: Apple has just recently begun incorporating native Hi-Speed USB 2.0 host bus interface adapters. To achieve Hi-Speed USB 2.0 data transfer rates, you will need to purchase a third-party Hi-Speed USB 2.0 host interface PCI or PC card. Otherwise, you will be limited to USB 1.1 speeds.

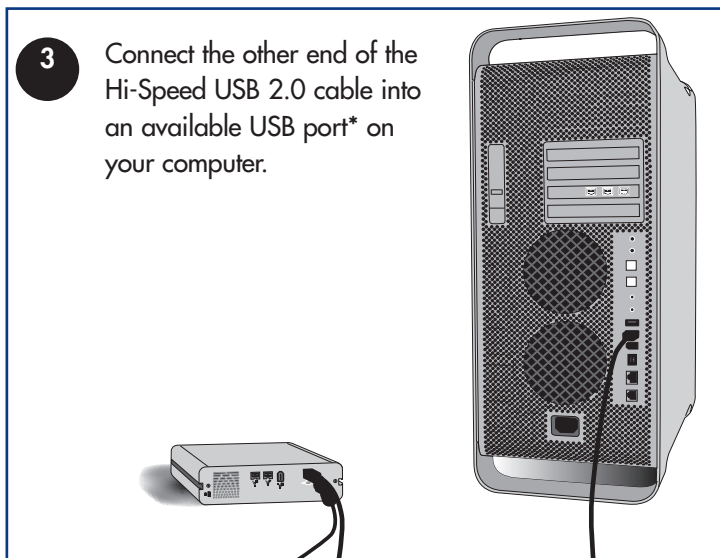
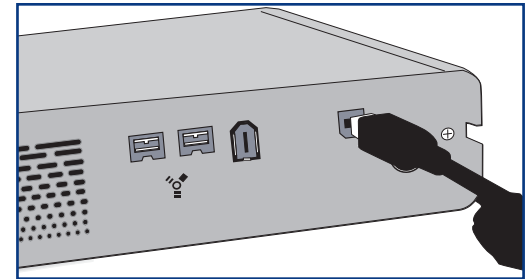

- 3 Connect the other end of the Hi-Speed USB 2.0 cable into an available USB port* on your computer.



Tech Note: For more information about USB, please see sections:

- [2.3.2. USB](#)
- [5.3. Optimizing Data Transfers](#)
- [7. USB Questions & Answers.](#)

- 4 Your drive should appear on your desktop. It may take a few seconds for your computer to recognize the drive and for it to appear on the desktop.

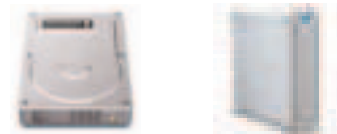

Mac OS Drive Icons

Your LaCie Big Disk Extreme with Triple Interface will now be ready for use. You can then use the formatting and partitioning capabilities in the Apple Disk Utility to configure your hard drive system. Please refer to [4.1. Formatting And Partitioning Your LaCie Drive – 4.1.1. Mac Users](#) for more information.

Mac OS 9.x – USB

To use your new LaCie Big Disk Extreme with Triple Interface, first install the necessary driver software.

Silverlining Pro Installation

- 1) Insert the LaCie Storage Utilities CD in your computer's internal CD/DVD drive.
- 2) Open the CD icon and double-click on the **Silverlining Installer**.
- 3) The Silverlining Utilities screen appears. Click on **Continue**.
- 4) The **About to Install** screen appears. Read the following information and click on **Continue**.
- 5) The **License Agreement** screen appears. Click on **Agree**.
- 6) The **Installation** screen appears.
- 7) Check the **Silverlining Pro** and **USB Support** boxes.
- 8) Click on **Install**.
- 9) A message appears to confirm that the installation was successful.
- 10) Click on **Restart** to use your USB peripheral immediately.

Now you are ready to move to the next step, Connecting the Drive to the Computer.

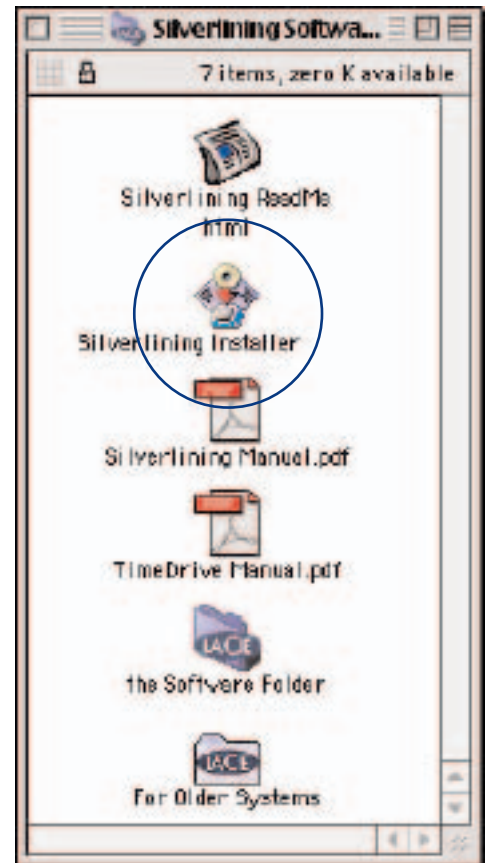

Mac OS 9.x – USB

- 1 After following the steps in [3.1. Connecting The Power Supply](#), power on the drive by pressing the On/Off button on the front of the drive.
- 2 Connect the Hi-Speed USB 2.0 cable into the Hi-Speed USB 2.0 port on the back of the LaCie Big Disk Extreme with Triple Interface.



Tech Note: Apple does not support the Hi-Speed USB 2.0 standard under Mac OS 9.x. You will be limited to USB 1.1 speeds.

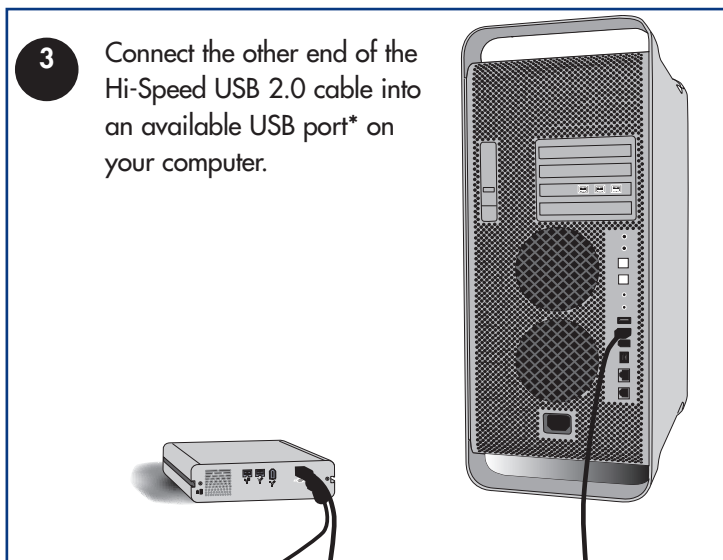
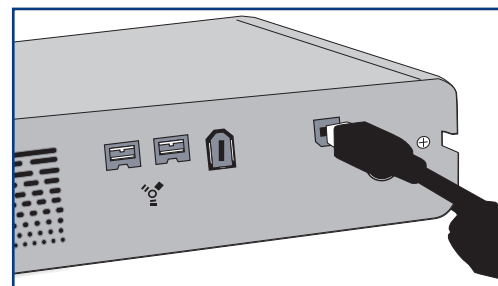

- 3 Connect the other end of the Hi-Speed USB 2.0 cable into an available USB port* on your computer.



Tech Note: For more information about USB, please see sections:

- [2.3.2. USB](#)
- [5.3. Optimizing Data Transfers](#)
- [7. USB Questions & Answers.](#)

- 4 Your drive should appear on your desktop. It may take a few seconds for your computer to recognize the drive and for it to appear on the desktop.



Mac OS Drive Icons

Your LaCie Big Disk Extreme with Triple Interface will now be ready for use. You can then use the formatting and partitioning capabilities in **Silverlining Pro** to configure your hard drive system. Please refer to the **Silverlining Pro** documentation on the LaCie Storage Utilities CD-ROM for more information.

3.2.2. Windows Users

These installation steps are separated by interface and version of Windows operating system. To view the installation steps of the interface and operating system you plan on using, click on the appropriate interface:

[Windows 2000/Windows XP – FireWire 800](#)

[Windows 2000/Windows XP – FireWire/IEEE 1394](#)

[Windows 2000/Windows XP – iLink/DV](#)

[Windows 2000/Windows XP – Hi-Speed USB 2.0](#)



Important Info: You can not have the FireWire and USB interfaces connected at the same time! If you will be switching between interfaces, you must also follow the steps in section [3.6. Switching Interfaces](#).



Tech Note: To daisy-chain devices, you must be using the same interface FireWire. Your computer will not recognize the daisy-chained device if the interfaces are mixed, i.e. a FireWire device attached to a drive that is connected to the computer via the Hi-Speed USB 2.0 interface.

Daisy-chain configurations:

- FireWire 400 device connected directly to the LaCie Big Disk Extreme with Triple Interface, which is connected to the computer via the FireWire 800 port.
- iLink/DV device connected directly to the LaCie Big Disk Extreme with Triple Interface, which is connected to the computer via the FireWire 800 port.
- FireWire 800 device connected directly to the LaCie Big Disk Extreme with Triple Interface, which is connected to the computer via the FireWire 800 port.

Windows 2000 And Windows XP – FireWire 800

After the first connection of a FireWire 800-based peripheral, Windows detects the drive, and will install it automatically as a new peripheral, even if you have previously installed it on another port on the same FireWire bus. Let Windows install the FireWire 800 drivers of your LaCie drive.

1 After following the steps in [3.1. Connecting The Power Supply](#), power on the drive by pressing the On/Off button on the front of the drive.

2 Connect the 9-pin end of the FireWire 800 cable into the FireWire 800 port on the back of the LaCie Big Disk Extreme with Triple Interface.

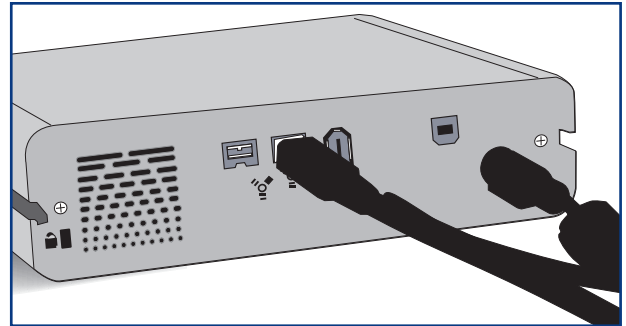

3 Connect the other end of the 9-pin FireWire 800 cable into an available FireWire 800 port on your computer.

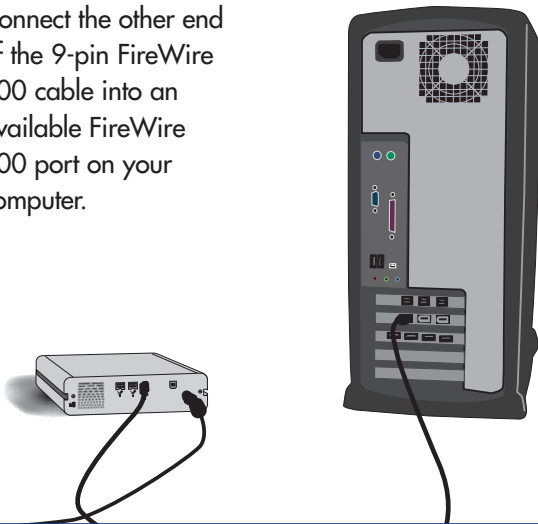

Tech Note: For more information about FireWire, please see sections:

- [2.3.1. FireWire](#)
- [5.3. Optimizing Data Transfers](#)
- [6. FireWire Questions & Answers.](#)

4 Your LaCie Big Disk Extreme with Triple Interface will now be ready for use. Now you will need to format and partition the drive to suit your needs. Please see [4.1. Formatting And Partitioning Your LaCie Drive – 4.1.2. Windows Users](#) for more information.

Windows 2000 And Windows XP – FireWire 400

After the first connection of a FireWire-based peripheral, Windows detects the drive, and will install it automatically as a new peripheral, even if you have previously installed it on another port on the same FireWire bus. Let Windows install the FireWire drivers of your LaCie drive.

1 After following the steps in [3.1. Connecting The Power Supply](#), power on the drive by pressing the On/Off button on the front of the drive.

2 Connect the 6-pin end of the FireWire 400 cable into the FireWire 400 port on the back of the LaCie Big Disk Extreme with Triple Interface.

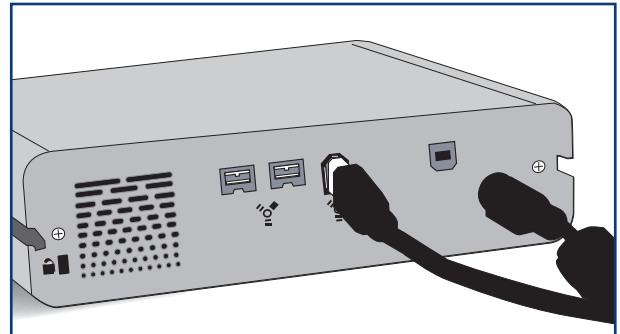

3 Connect the 6-pin end of the FireWire 400 cable into an available FireWire 400 port on your computer.

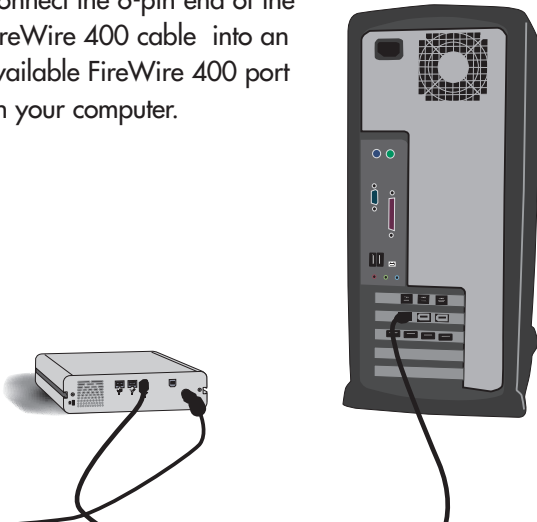

Tech Note: For more information about FireWire, please see sections:

- [2.3.1. FireWire](#)
- [5.3. Optimizing Data Transfers](#)
- [6. FireWire Questions & Answers.](#)

4 Your LaCie Big Disk Extreme with Triple Interface will now be ready for use. Now you will need to format and partition the drive to suit your needs. Please see [4.1. Formatting And Partitioning Your LaCie Drive – 4.1.2. Windows Users](#) for more information.

Windows 2000 And Windows XP – iLink/DV

After the first connection of a FireWire-based peripheral, Windows detects the drive, and will install it automatically as a new peripheral, even if you have previously installed it on another port on the same FireWire bus. Let Windows install the FireWire drivers of your LaCie drive.

- 1 After following the steps in [3.1. Connecting The Power Supply](#), power on the drive by pressing the On/Off button on the front of the drive.
- 2 Connect the 6-pin end of the iLink/DV cable into the FireWire 400 port on the back of the LaCie Big Disk Extreme with Triple Interface.

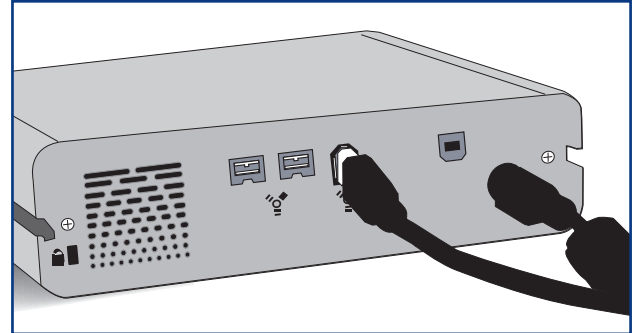

- 3 Connect the 4-pin end of the iLink/DV cable into an available iLink/DV port on your computer or device.

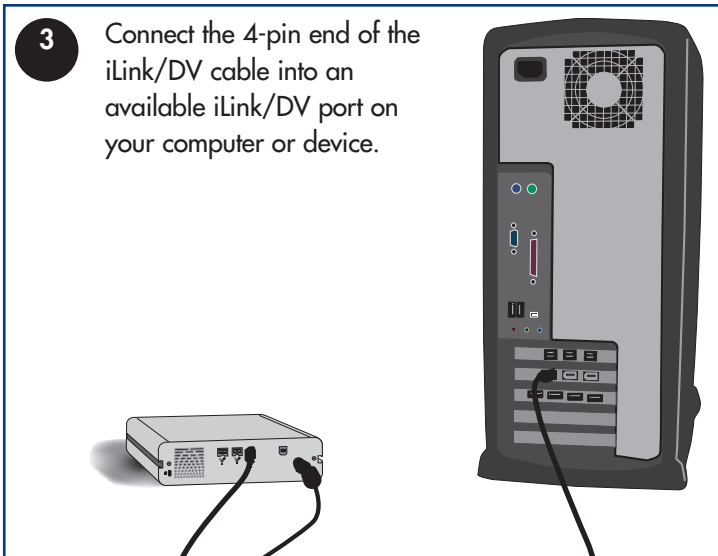

Tech Note: For more information about FireWire, please see sections:

- [2.3.1. FireWire](#)
- [5.3. Optimizing Data Transfers](#)
- [6. FireWire Questions & Answers.](#)

- 4 Your LaCie Big Disk Extreme with Triple Interface will now be ready for use. Now you will need to format and partition the drive to suit your needs. Please see [4.1. Formatting And Partitioning Your LaCie Drive – 4.1.2. Windows Users](#) for more information.

Windows 2000 And Windows XP – Hi-Speed USB 2.0

After the first connection of a USB-based peripheral, Windows detects the drive, and will install it automatically as a new peripheral, even if you have previously installed it on another port on the same USB bus. Let Windows install the USB drivers of your LaCie drive.

1 After following the steps in [3.1. Connecting The Power Supply](#), power on the drive by pressing the On/Off button on the front of the drive.

2 Connect the Hi-Speed USB 2.0 cable into the Hi-Speed USB 2.0 port on the back of the LaCie Big Disk Extreme with Triple Interface.



Tech Note: To achieve Hi-Speed USB 2.0 transfer rates, you have to be connected to a Hi-Speed USB 2.0 port on your computer. Otherwise, you will be limited to USB 1.1 data transfer rates.

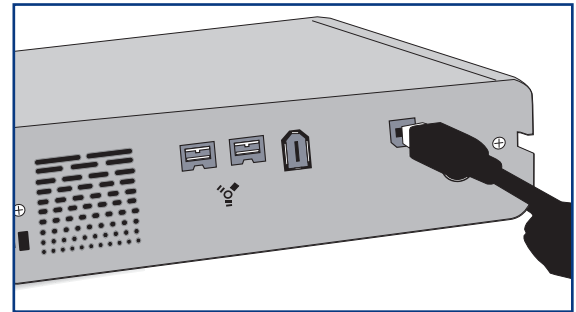

3 Connect the other end of the Hi-Speed USB 2.0 cable into an available USB port* on your computer.

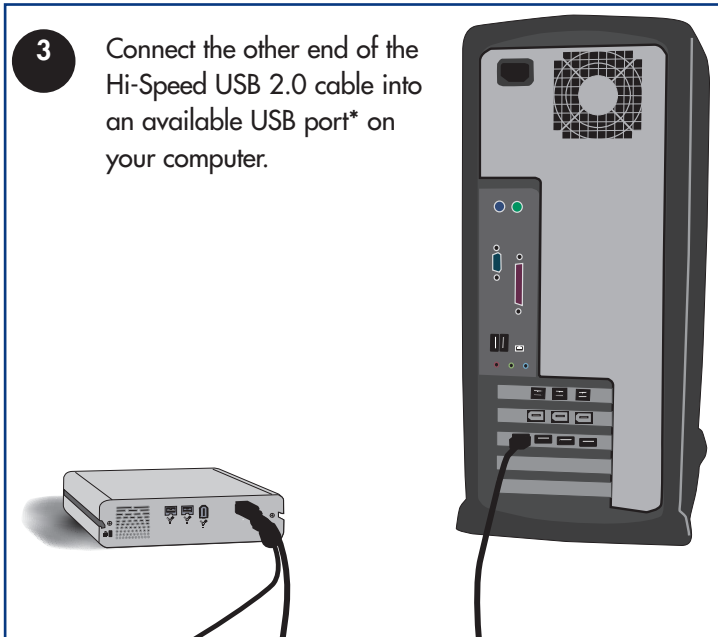

Tech Note: For more information about USB, please see sections:

- [2.3.2. USB](#)
- [5.3. Optimizing Data Transfers](#)
- [7. USB Questions & Answers.](#)

4 Your LaCie Big Disk Extreme with Triple Interface will now be ready for use. Now you will need to format and partition the drive to suit your needs. Please see [4.1. Formatting And Partitioning Your LaCie Drive – 4.1.2. Windows Users](#) for more information.

3.3 Connecting Digital Video Cameras To The LaCie Drive

With both FireWire 400 and FireWire 800 interfaces, it is possible to connect a digital video camera directly to the LaCie Big Disk Extreme with Triple Interface* (this connection is called "daisy-chaining").



Important Info: You can not have the FireWire and USB interfaces connected at the same time! If you will be switching between interfaces, you must also follow the steps in section [3.6. Switching Interfaces](#).



Tech Note: To daisy-chain devices, you must be using the same interface (FireWire). Your computer will not recognize the daisy-chained device if the interfaces are mixed, i.e. a FireWire device attached to a drive that is connected to the computer via the Hi-Speed USB 2.0 interface.

Daisy-chain configurations:

- FireWire 400 device connected directly to the LaCie Big Disk Extreme with Triple Interface, which is connected to the computer via the FireWire 800 port.
- iLink/DV device connected directly to the LaCie Big Disk Extreme with Triple Interface, which is connected to the computer via the FireWire 800 port.
- FireWire 800 device connected directly to the LaCie Big Disk Extreme with Triple Interface, which is connected to the computer via the FireWire 800 port.

1

Follow the steps in either [Windows 2000/Windows XP – FireWire 800](#) or [Mac OS 10.x – FireWire 800](#) to connect the LaCie Big Disk Extreme with Triple Interface to the FireWire 800 interface.



Tech Note: If you do not have FireWire 800 capability on your computer, there are two options to be able to use the daisy-chaining functionality: 1) add a FireWire 800 PCI or PC Card to your computer (see section [5.3. Optimizing Data Transfers](#) for more information); 2) purchase a FireWire 800 9-pin-to-6-pin interface cable, which you can use to attach to the FireWire 800 port of your LaCie drive and a FireWire 400 port on your computer.

2

Using the iLink/DV cable, connect the 4-pin end of the cable to the 4-pin port on your digital camera.

3

Connect the 6-pin end of the iLink/DV cable to the 6-pin FireWire port on the back of the LaCie Hard Drive.

The digital camera should now appear under **My Computer** (Windows users) or on the desktop (Mac users).

*Some cameras do not support this configuration or may downgrade the performances of your LaCie Big Disk.

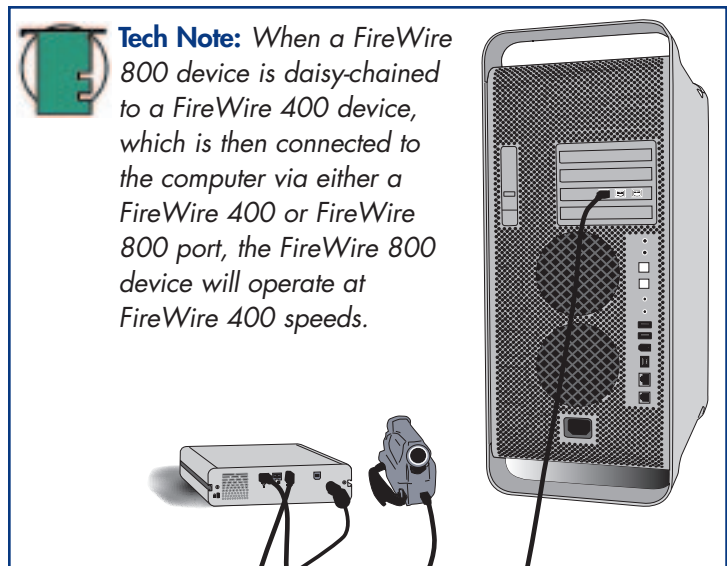

3.4. Installing Multiple Devices

Both the FireWire and USB interfaces allow for multiple devices to be connected.

3.4.1. FireWire

FireWire 400 and FireWire 800 allow for the connection of up to 63 devices on the bus, with a maximum of 16 devices on one branch. FireWire 400 and FireWire 800 devices can be connected on a chain and do not necessarily need a hub. Simply connect the first peripheral to a FireWire 400 or FireWire 800 port on your computer. Connect the second peripheral to the other FireWire 400 or FireWire 800 port on the first drive etc., using the cables provided with your drives.

FireWire 800 devices can be chained together with the original FireWire 400 standard (provided the correct cables are used), but transfer rates will be limited to the original FireWire 400 speeds. For reliable performance, LaCie does not recommend daisy-chaining more than 4 FireWire devices one after the other; instead, use several FireWire cards/ports directly from the computer.



Tech Note: To daisy-chain devices, you must be using the same interface, either FireWire or USB. Your computer will not recognize the daisy-chained device if the interfaces are mixed, i.e. a FireWire device attached to a drive that is connected to the computer via the Hi-Speed USB 2.0 interface.

Daisy-chain configurations:

- FireWire 400 device connected directly to the LaCie Big Disk Extreme with Triple Interface, which is connected to the computer via the FireWire 800 port.
- iLink/DV device connected directly to the LaCie Big Disk Extreme with Triple Interface, which is connected to the computer via the FireWire 800 port.
- FireWire 800 device connected directly to the LaCie Big Disk Extreme with Triple Interface, which is connected to the computer via the FireWire 800 port.



Tech Note: For more information about FireWire and improving performance, please sections [5.3. Optimizing Data Transfers](#) and [6. FireWire Questions & Answers](#).

3.4.2. USB

Technically, you can connect up to 127 individual USB peripherals at one time. However, you probably will not use more than 6 to 8 peripherals on your USB system. Most computers only have two USB ports, so you would need a hub to connect more than two peripheral drives. The hub regenerates the signals, generally providing between 4 to 7 connections. To add even more drives, connect a new hub to a connector of the original hub, creating a new series of peripherals, etc. But the hub slows down the transfer rate by lengthening the path of the signal. To optimize performance, connect your drive directly to one of the built-in ports in your computer.



Tech Note: For more information about USB and improving performance, please sections [5.3. Optimizing Data Transfers](#) and [7. USB Questions & Answers](#).

3.5. Disconnecting Your LaCie Drive

FireWire and USB external devices feature “plug & play” connectivity, which means that your drive can be connected and disconnected while the computer is running. To prevent failures, it is important you follow these steps when disconnecting your FireWire or USB peripheral device.



Caution! Do not disconnect the USB or FireWire cable when the drive is reading or writing. Disconnecting while the drive is operating could cause the loss of data. Make sure that your drive is not reading or writing and that the activity LED is off before disconnecting the USB or FireWire cable.



3.5.1. Windows Users

- 1 From the System Tray (located in the lower right-hand side of your screen), click on the **Eject** icon (a small green arrow over a hardware image).
- 2 A message will appear, detailing the devices that the **Eject** icon controls, i.e. “Safely remove...” Click on this prompt.
- 3 You will then be given the following message: “Safe to Remove Hardware” (or similar). It is now safe to disconnect the device.

3.5.2. Mac Users

You must unmount the hard drive system before disconnecting it or powering it down. Either:

- Drag the hard drive icon to the trash.
- Launch **Silverlining Pro**, highlight the hard drive and select “Unmount.”

The drive can now be disconnected.



3.6. Switching Between USB And FireWire Connections

Hi-Speed USB 2.0, FireWire 400 and FireWire 800 are "hot-pluggable," meaning that you can connect a drive to a USB or FireWire port on your computer even when the computer is running. However, there are important steps to follow for your drive to function properly. When changing from a Hi-Speed USB 2.0 connection to a FireWire 400 or FireWire 800 connection (and vice versa), follow these steps:

- 1 Follow the steps in section [3.5 Disconnecting Your LaCie Drive](#) to unmount the drive.
- 2 Disconnect the USB or FireWire cable.
- 3 Connect either the USB or FireWire cable.

After switching between interfaces, you may need to quit the application that you were using to access the drive and then reboot the program. The drive should then be visible and accessible.

4. Using Your LaCie Drive

Once you've connected your drive, you are ready to format and partition the drive. In order to store information on a hard drive, it must have a file system and be divided into sections that will contain the data that you wish to store. This process is called formatting.

In order to utilize a hard disk drive, it has to be formatted first. Formatting a disk consists of the following: the operating system erases all of the bookkeeping information on the disk, tests the disk to make sure that all of the sectors are reliable, marks bad sectors (i.e., those that are scratched) and creates internal address tables that it later uses to locate information. Once formatted, the actual available storage capacity varies, depending on operating environment, and is generally about 10% less than the non-formatted capacity.



Tech Note: Windows Users! *This LaCie Hard Drive is formatted for the Mac operating system, and you will need to re-format the drive in order for it to appear and operate under the Windows operating system.*

After you've formatted the drive, you will have the opportunity to divide the hard drive into sections, called partitions. A partition is a section of the hard drive's storage capacity that is created to contain files and data. For instance, you could create three partitions on your drive: one partition for your word documents, one for your spreadsheets and one for your multi-media files.

File System Formats

There are essentially three different file system formats: FAT 32, NTFS, and Mac OS Extended (HFS+).

Use FAT 32 if:

- you will be using your drive between both Windows and Mac OS 9.x or 10.x; or sharing the drive between Windows 2000 or XP

Use NTFS if:

- you will be using the drive only under Windows 2000 or Windows XP; performance will generally be greater when compared to FAT 32

Use HFS+ if:

- you will be using the drive on Macs only; performance will generally be greater when compared to FAT 32

For more information, please refer to section [5.1 File System Formats](#).

4.1. Formatting And Partitioning Your LaCie Big Disk Extreme with Triple Interface

Once you have set-up your LaCie Big Disk Extreme with Triple Interface, you can reformat or partition it to suit your needs.

4.1.1. Mac Users

- Mac OS 9.x – Install and use LaCie **Silverlining Pro**, which is included with your drive.
- Mac OS 10.x – Use the Apple Disk Utility application, which is native to the operating system.

For instructions on installing and using **Silverlining Pro**, please refer to the **Silverlining** manual, located on your LaCie Storage Utilities CD, in PDF format.

For instructions on using the Mac OS 10.x Apple Disk Utility application, please refer to the section below.

Formatting And Partitioning Using Mac OS 10.x



Caution! Following these steps will erase anything that is on the hard drive. Therefore, if you have information that you want to protect or continue to use, backup this information before performing these steps.

- 1) Connect the drive to the computer via one of the interface ports.
- 2) Once the drive mounts onto the desktop, go to the **Menu Bar**, and open **Go**.
- 3) From the **Go** menu, click on **Applications**.
- 4) In the **Applications** menu, open the **Utilities** folder, and then double-click **Disc Utility** from the **Utilities** folder.
- 5) The **Disc Utility** window will open. In the left side of the window will be a list of the available hard disk drives. You should see a volume that represents your internal hard drive, and one that reads LaCie.
- 6) Select the LaCie drive, and then click on the **Partition** tab.
- 7) From the **Volume Scheme:** button, choose the number of partitions you want to divide the drive into by clicking on the pull down menu

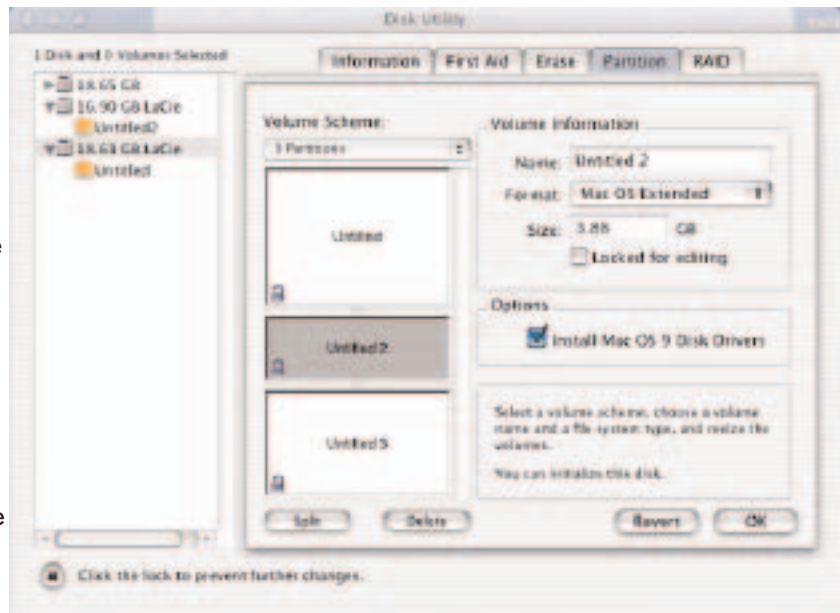

starting with **Current** (Mac OS 10.x gives you the option of dividing the drive into at most 8 partitions). You can customize the size of the partitions by using the slide bar between the partitions in the **Volume Scheme:** area.

8) In the **Volume Information** section, create a name for each partition, choose the volume format (Mac OS Extended, Mac OS Standard, MS-DOS File System or UNIX File System) and the volume size.



Tech Note:

- Please refer to section [5.1.1. File System Formats – Mac Users](#), for a more detailed discussion on the differences between the two systems.
- If you want to format the drive in the MS-DOS File System (also known as FAT 32), you will need to create multiple partitions no larger than 128GB.
- Apple recommends that unless you have a specific reason to use the UNIX File System (UFS), you should use the Mac OS Extended format since it provides a more familiar experience to Macintosh users.

9) In the **Options** section, click the **Install Mac OS 9 Disk Drivers** box if you plan on sharing the drive between the Mac OS 9.x and Mac OS 10.x.

10) Once you have finalized the volume format, number of partitions, size and options, click OK. The following message will appear: "Warning! Saving the new volume will erase all existing volumes. This can NOT be undone. Are you sure you want to do that?" Click **Partition** to continue.

11) Mac OS 10.x will automatically setup the disk with the partitions and volume format you selected, and your new drive will be available for use.

4.1.2. Windows Users

- Windows 2000 and XP – Use the Disk Management Utility, which is native to the operating system.

For instructions on installing and using **Silverlining 98**, please refer to the **Silverlining 98** manual, located on your LaCie Storage Utilities CD, in PDF format.

Formatting And Partitioning Using Windows 2000 And Windows XP

The process of formatting and partitioning a drive on a computer running Windows 2000 or Windows XP consists of two steps: (1) installing a signature on the drive, and (2) partitioning/formatting the drive. These steps will erase anything that is on the disk.

- 1) Connect the drive to the computer via one of the interface ports.
- 2) Right-click **My Computer** and click **Manage**.
- 3) From the **Computer Management** window, select **Disk Management** (located below the Storage group).

4) If this is the first time the drive is being formatted, Windows 2000 will launch the **Write Signature Wizard (Write Initialize Wizard)** in Windows XP). Click **Next**.

5) Windows will list the new drive(s) attached. If you are formatting a single drive, only one drive should be visible. Select the checkbox next to the drive and click **Next**.



Important Info: Check the "quick format" box.

6) Click **Finish** to exit the Wizard.

7) Now, with the disk management window open, a new drive will be visible. Right-click on the available space and select **Create Partition...**

8) This will bring up the **Create Partition Wizard**. Click **Next**.

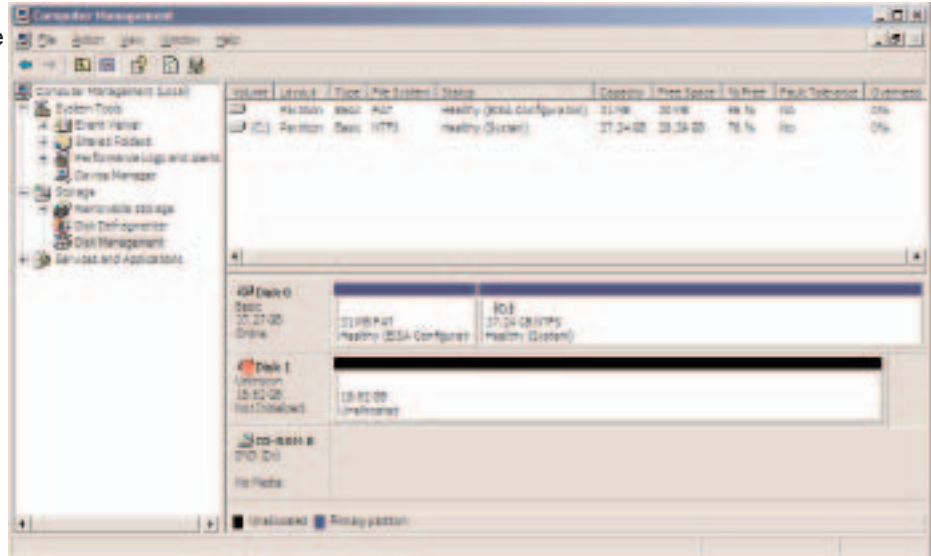

9) Select **Primary Partition**. Click **Next**.

10). Here you must specify partition size. It is recommended that you leave the partition set to the maximum available size, unless you want multiple partitions on the same drive. Click **Next**.

11) Select **Assign drive letter** and select the desired letter for the drive. Click **Next**.

12) Select **Format this partition...** and then select a file system:

FAT32

FAT32 is a file system that is compatible with Windows 98 SE, Windows Me, Windows 2000 and Windows XP; however, it has limitations. In Windows 2000 and Windows XP, you will not be able to create a partition greater than 32GB.

NTFS

NTFS is a newer file system that is compatible only with Windows NT, Windows 2000 and Windows XP. It has fewer limitations than FAT 32 and will enable a partition to be created that is larger than 32GB.

 **Tech Note:** Please refer to section [5.1.2. File System Formats – Windows Users](#), for a more detailed discussion on the differences between the two systems.

13) Click **Next**.

14) Click **Finish**.

15) **Disk Management** will create the partition and begin formatting the drive. Once completed, close **Disk Management** and your new drive will be ready to use.

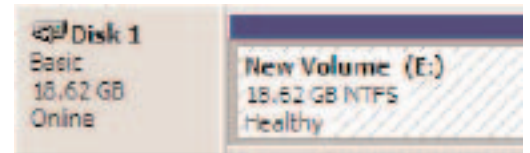
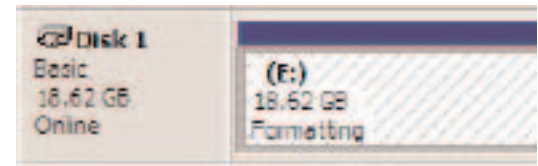
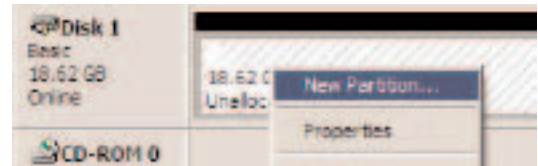

5. Tech Tips

5.1 File System Formats

5.1.1. Mac Users

Mac OS 9.x Users:

You will be able to format the drive in one of two formats, using Silverlining Pro (for specific instructions, please refer to the Silverlining User's Manual, in the Silverlining folder): HFS (Mac OS Standard) or HFS+ (Mac OS Extended).



Important Info: *If you will be sharing the hard drive between Mac and Windows operating environments, you will want to format the drive in MS-DOS (FAT 32).*

Mac OS 10.x Users:

You have the option of formatting the drive in one of four formats: Mac OS Standard (HFS), Mac OS Extended (HFS+), MS-DOS File System and UNIX File System (UFS).

HFS - Mac OS Standard

Mac OS Standard refers to the file system used by Mac OS 8.0 and earlier. This is no longer a modern file system specification, and Mac OS Extended is more efficient. Only use this file system if you are creating a volume smaller than 32MB, using a Mac with a 680X0 processor, or you are creating a file structure that will be needed to be used by Macs using Mac OS 8.0 or earlier.

HFS+ - Mac OS Extended

Mac OS Extended refers to the file system used by Mac OS 8.1 and later. HFS+ represents an optimization of the older HFS file system by using hard disk space more efficiently. Building off of HFS, they increased the number of blocks from 65,536 to 4.29 billion. With HFS+, you are no longer limited by block size.

MS-DOS File System

This is the Microsoft file system, more typically known as FAT 32. This is the file system to use if you are going to be using your LaCie Big Disk Extreme with Triple Interface between Macs and Windows operating systems.

UNIX File System

This is the file system based on UNIX, and is preferable for users developing UNIX-based applications within Mac OS 10.x. Unless you have a specific reason to use the UNIX File System, you should instead format your drive using Mac OS Extended (HFS+), because it provides Mac users with a more familiar operating experience.

5.1.2. Windows Users

There are basically two file system formats for Windows: FAT 32 and NTFS. The following information will hopefully make choosing one or the other a little easier.

FAT 32

FAT is an acronym for File Allocation Table, which dates back to the beginnings of DOS programming. Originally, FAT was only 16 bits, but after the second release of Windows 95 it was upgraded to 32 bits, hence the name FAT 32. In theory, FAT 32 volume sizes can range from less than 1MB all the way to 2TB. It is the native file system of Windows 98 and Windows Me, and is supported by Windows 2000 and XP. When FAT 32 is used with Windows 2000 and XP, though, volume size is limited to 32GB (by the Windows partition utility, i.e. Disk Manager), and the individual file size is limited to 4GB.

NTFS

This acronym stands for New Technology Filing System, and it is the native file system for Windows NT, Windows 2000 and XP. NTFS offers several features that are not available with FAT 32; i.e. file compression, encryption, permissions, and auditing, as well as the ability to mirror drives and RAID 5 capabilities. The minimum supported volume size for NTFS is 10MB, with a maximum of 2TB, with no limit to file size. Volumes created in NTFS can only be directly accessed (not through shares) by Windows NT, Windows 2000 and XP, without resorting to help from third-party products.

Guidelines for Choosing FAT 32 Or NTFS

Use FAT 32 if:

- You want to access your data on any Operating System - FAT 32 is compatible with Windows 98 SE, Me, 2000, XP, NT, Mac OS 9.x and Mac OS 10.x.
- You will be dual booting with an Operating System other than Windows NT or Windows 2000.
- You may need the ability to dual boot down the line. Once you have converted a volume from FAT 32 to NTFS, there is no going back. You can convert from FAT 32 to NTFS, but not the other way around.

Use NTFS if:

- You want to optimize drive performance under Windows 2000 or XP.
- You want to encrypt files, assign permissions to files, or want to audit files for access.
- You will be formatting partitions larger than 32GB.
- You need to store individual files that are larger than 4GB.
- You need a filing system that can be mirrored or structured like a RAID 5 configuration.

5.2. Available Storage Capacity

A gigabyte (GB) means 1,000,000,000 bytes. In order to utilize a hard disk drive, it has to be formatted first. Formatting a disk consists of the following: the operating system erases all of the bookkeeping information on the disk, tests the disk to make sure that all of the sectors are reliable, marks bad sectors (i.e., those that are scratched) and creates internal address tables that it later uses to locate information. Once formatted, the actual available storage capacity varies, depending on operating environment, and is generally about 10% less than the non-formatted capacity.

5.3. Optimizing Data Transfers

Data transfers are the flow of data that accomplishes a task, usually related to moving data from storage to computer RAM, or between storage devices. With external drives, such as the LaCie Big Disk Extreme with Triple Interface, the data is transferred from the drive to the computer via the FireWire or USB interface. The data is fed from the drive through the FireWire or USB port on the drive, and passes to the computer through either the FireWire or USB host-bus adapter interface.

Computer manufacturer's implementation of the FireWire and USB host-bus adapter interfaces vary widely. For computers running Windows 2000 and later, the Hi-Speed USB 2.0 interface is a fairly standard feature, while FireWire, which is referred to as either IEEE 1394 or iLink on PCs*, is less common as a native host-bus adapter. Nearly all recent Apple computers have native FireWire interface ports, and they also support the original USB standard*, while Hi-Speed USB 2.0 has only just recently been adopted.



***Tech Note:** For more information on the FireWire and USB interfaces, please see: [6.FireWire Questions & Answers](#) [7.USB Questions & Answers.](#)

The FireWire and USB interfaces specify certain requirements, filed under the OHCI (Open Host Controller Interface) standards. All LaCie drives comply to OHCI standards and have been rigorously tested on computers that have host bus adapters that also comply to OHCI standards. Unfortunately, not all manufacturers respect these guidelines, and anomalies may arise with computers that have host bus adapters that do not conform to OHCI standards.



Tech Note: Please see [3.4 Connecting Multiple Devices](#) for more information.

For the best performance, connect your LaCie Big Disk Extreme with Triple Interface directly to a native FireWire or USB port on your computer, and avoid daisy-chaining* or using hubs*. During data transfers, it's best to wait before launching other applications that will be using the same port.



Tech Note: Another important factor in file transfer speeds is how the drive has been formatted. For more information in choosing the correct file system format, please see section [5.1 File System Formats.](#)

If you do not have a native FireWire or USB port, LaCie offers FireWire and USB host bus adapter cards, also known as PCI or PC/PCMCIA cards, that have been tested and comply with LaCie drives. Please contact your reseller or [LaCie Customer Support](#) for more information.

5.3.1. FireWire 800 Ports And Performance

To utilize the newly enhanced FireWire 800 performances, your computer must be equipped with a FireWire 800 host bus adapter card (either sold separately, or integrated by your computer's manufacturer). These host bus adapter cards include one or more FireWire 800 ports, but you must be running Mac OS 10.2.4 and higher, or Windows 2000 or Windows XP in order to achieve FireWire 800 performance and functionality.

At the time of publication (April, 2005), only Mac OS 10.2.4 and higher, and Windows 2000 and Windows XP, support FireWire 800 functionality, and the IEEE 1394b interface is not a standard feature implemented on the motherboards of all PC-compatible computers.

Contact your LaCie reseller or [LaCie Customer Support](#) for information about FireWire 800 PCI or PC Cards, or visit our Web site: www.lacie.com.

5.3.2. Hi-Speed USB 2.0 Ports And Performance

To utilize the enhanced Hi-Speed USB 2.0 performance, your computer must be equipped with a Hi-Speed USB 2.0 host bus adapter card (either sold separately, or integrated by your computer's manufacturer) and the appropriate drivers. These host bus adapter cards, which include one or more USB ports, are shipped with special Hi-Speed USB 2.0 drivers that enable the computer to control the card. These drivers must be installed in order for USB 2.0 devices connected to the port to work at their correct speeds.

Computers running Windows 2000 and Windows XP automatically manage Hi-Speed USB 2.0 devices and drivers.

Mac OS 9.x does not support Hi-Speed USB 2.0 functionality, and all Hi-Speed USB 2.0 devices will only operate at the original USB specifications. Mac OS 10.2.7 and later supports Hi-Speed USB 2.0, and Mac OS 10.x also supports Hi-Speed USB 2.0, but you will have to purchase a third-party PCI or PC Card and appropriate drivers.

Contact your LaCie reseller or [LaCie Customer Support](#) for information about Hi-Speed USB 2.0 PCI or PC Cards, or visit our Web site: www.lacie.com.

5.4. Hi-Speed USB 2.0 vs. FireWire 400 vs. FireWire 800

Trying to decide which interface to use, Hi-Speed USB 2.0, FireWire 400 or FireWire 800, can be a complicated decision. Your decision should be based on the following:

Computer With Hi-Speed USB 2.0, FireWire 400 And FireWire 800 Ports

If your computer is equipped with all three interfaces, you have several options to consider. The key decision in this equation is simple: speed. FireWire 800 effectively offers twice the bandwidth of both Hi-Speed USB 2.0 and FireWire 400. So, if you are running bandwidth-intensive applications, such as digital audio, video or graphics, FireWire 800 is your clear choice.

Computer With Hi-Speed USB 2.0 And FireWire 400 Ports

If your computer is equipped with both Hi-Speed USB 2.0 and FireWire ports, drive performance will be relatively similar. The theoretical transfer rates are 480Mb/s for Hi-Speed USB 2.0 and 400Mb/s for FireWire. Realistically, the two are extremely close to each other in terms of performance and speed.

The main reason for choosing one over the other should be hinged on the existing devices you are already using. For instance, if you are already using both of your Hi-Speed USB 2.0 ports on your computer, you would use the FireWire port to connect your drive, and vice versa. Avoiding hubs (for USB topology) and daisy-chains (for FireWire topology) will help improve performance because your drive will be connected directly to your computer.

Computer With USB And FireWire 400 Ports

If your computer is equipped with a USB port and a FireWire port, you will get noticeably better performance by using the FireWire connection. Even though your LaCie drive comes with a Hi-Speed USB 2.0 cable and interface, by connecting through the USB port, the drive will be limited to USB 1.1 speeds and performance.

Computer With Only USB Ports

If your computer is only equipped with a USB port, your decision is fairly simple: connect via the USB cable provided with your drive. Hi-Speed USB 2.0 is backward compatible and can be used in USB ports. Again, you will be limited to USB speeds and performance.

Another alternative is to purchase a FireWire or Hi-Speed USB 2.0 host adapter card that you would install into a PCI or PCMCIA slot on your computer, thereby allowing your computer to take advantage of the performances that FireWire and Hi-Speed USB 2.0 have to offer.

Contact your LaCie reseller or [LaCie Customer Support](#) for information about FireWire and Hi-Speed USB 2.0 PCI or PC Cards, or visit our Web site: www.lacie.com.

6. FireWire Questions & Answers

What Does IEEE 1394 Mean?

IEEE (the Institute of Electrical and Electronics Engineers) refers to the engineering corps that developed the 1394th standard, defining the high-performance serial input/output (I/O) bus used to connect peripheral devices. There are now two standards: IEEE 1394a, which refers to the original standard adopted in 1995, and IEEE 1394b, which refers to the new standard, adopted in 2002.

What Is The Relationship Between IEEE 1394, FireWire, iLink And DV?

These four names all refer to the same interface:

- IEEE 1394 is the term commonly used in the computer industry.
- FireWire is the brand name used by Apple.
- iLink is the brand name used by Sony for both consumer electronics and personal computers.
- DV is short for "Digital Video," and is used as the logo for the interface on most video camcorders.

What Are The Benefits Of The FireWire Interfaces?

The FireWire interface is a fast, cross-platform serial bus, and is ideal for digital audio, video and graphic applications that demand plenty of bandwidth. Both versions of FireWire offer Plug & Play connectivity, so all you have to do is plug in your drive and begin using it, they also allow up to 63 devices to be connected via a single bus and offer peer-to-peer connectivity, enabling multiple computers and FireWire devices to be connected at the same time. FireWire also supports both isochronous and asynchronous capabilities, meaning that it can guarantee real-time data delivery, so there is no danger of inaccurately ordered or delayed frames.

What Is The Difference Between FireWire 400 And FireWire 800?

Essentially, the main difference between the two interfaces can be summed up in one word: speed. FireWire 800 effectively doubles the bandwidth of the original FireWire 400 interface. The new FireWire 800 interface offers truly impressive results, with speeds up to 800Mb/s for a single bus, and even greater for several buses in RAID0 configurations.

Other key advancements include the support of increased cabling distances and a newly enhanced arbitration architecture. Utilizing cables constructed of professional-grade glass optical fiber, when both devices are connected via a FireWire 800 hub, FireWire 800 can burst data across 100 meters of cable.

The new arbitration scheme greatly improves on the existing architecture by incorporating advanced 8B10B data encoding (based on codes used by Gigabit Ethernet and Fibre Channel), which reduces signal distortion, and also improves the arbitration time by prepping the arbitration while the current data packet is being sent, so that data is sent as soon as the current transmission is completed.

What Are The Ideal Uses For FireWire?

FireWire helped fuel a revolution for digital content creators, and was awarded a 2001 Primetime Emmy Engineering Award by the Academy of Television Arts & Sciences for its contribution. Due to its high bandwidth and support of both isochronous and asynchronous data delivery, FireWire has found a very successful place in both the computer and consumer electronics industries. Whether connecting game consoles, personal video recorders, home stereo equipment, digital TVs, hard drives, CD/DVD-RW drives, printers, scanners, tape drives or other digital hardware equipment, FireWire is well-suited to handle all these various requirements.

With the advent of the new FireWire 800 standard, the revolution created by the original will only grow. For those working with digital video, the new standard will enable new bandwidth-intensive applications, such as multiple-stream, uncompressed, standard-definition video.

Will FireWire 400 Devices Run Faster When Connected To A FireWire 800 Port?

Unfortunately, this is not the case. In order to attain FireWire 800 speeds, both the device and port have to be FireWire 800 enabled. For instance, an external hard drive with a FireWire 800 9-pin connection will only reach FireWire 800 transfer rates when it is connected to a FireWire 800 9-pin host bus adapter card via a properly certified FireWire 800 9-pin to 9-pin beta cable.

When a FireWire 400 device is connected to a FireWire 800 port, the FireWire 400 device will only operate at the original FireWire 400 speeds.

Will FireWire 800 Devices Work On FireWire 400 Ports And Vice Versa?

The new standard was designed to be backwards compatible, meaning that FireWire 800 devices will still operate via the original FireWire 400 port. To connect a FireWire 800 device to a FireWire 400 port, a specific adapter cable must be used, though. There are two types of FireWire 400 ports: 6-pin and 4-pin. For FireWire 800 devices to work, they must be connected by placing the 9-pin end of the FireWire cable into the FireWire 800 port of the device, and the opposite 6-pin or 4-pin end into the FireWire 400 port.

The same holds true for FireWire 400 devices being connected to a FireWire 800 host port. The 4-pin or 6-pin end of the FireWire cable must be connected to the FireWire 400 port of the device, and the 9-pin end must be connected to the FireWire 800 port.

When FireWire 400 and FireWire 800 devices are mixed, all transfer rates revert to the original FireWire 400 speed.

What Do I Do If My Computer Does Not Have A FireWire Port?

Most computers manufactured today incorporate at least one FireWire port. If your computer does not have a native port, you can install one by adding a PCI or PCMCIA host bus adapter card. Please contact your computer supply specialist for a specific card that will work with your system.

For more information about the FireWire interface, please visit:

www.lacie.com/technologies

7. USB Questions & Answers

What Are The Benefits Of The USB Interfaces?

- Cross-platform: Use your USB peripherals on both Mac and Windows platforms.
- "Hot Swappable": No need to shut down or restart your computer when adding or removing a USB device. Plug it in and its ready.
- Automatic configuration: Once your device is connected, your computer recognizes the device and automatically configures the necessary software.
- Daisy-Chaining: with USB ports on your computer, you can connect up to 127 peripherals using hubs.
- Easy Installation: One standardized port and plug combination makes it simple to connect.

What Is The Difference Between USB And Hi-Speed USB 2.0?

The main difference is speed. The original version of the interface is capable of throughput up to 12Mb/s. Hi-Speed USB 2.0 supports data speeds up to 480 Mb/s, making it 40 times faster than its predecessor. This increased bandwidth translates into higher performance in demanding applications requiring high transfer rates.

What Are The Ideal Uses For USB?

USB is perfect for more traditional connections such as keyboards, mice, joysticks and scanners. These types of devices don't require fast data transfer rates, and operate very successfully at the slower speeds.

What Are The Ideal Applications For Hi-Speed USB 2.0?

Digital cameras, CD/DVD drives, hard drives and scanners will all benefit from the added bandwidth and performance gains of the new implementation of the USB standard. Hi-Speed USB 2.0 provides the necessary fast data transfer rates that today's devices require, and combines the earlier specifications so older devices that operated under the original USB standards will still work with Hi-Speed USB 2.0.

Will USB Devices Run Faster When Connected To A Hi-Speed USB 2.0 Bus?

Unfortunately, no. The Hi-Speed USB 2.0 specification is specifically written to allow developers to design higher speed peripherals that can take advantage of the extra bandwidth. USB devices, though, will still operate at 12Mb/s at full-speed and 1.5Mb/s at low-speed on a Hi-Speed USB 2.0 bus. Even though USB devices won't run any faster, they can work alongside Hi-Speed USB 2.0 devices on the same bus. However, if you plug in a Hi-Speed USB 2.0 device to a USB bus, the speed of the Hi-Speed USB 2.0 device will decrease to 12Mb/s.

What Is A USB Hub?

Technically, you can connect up to 127 devices to a single USB bus. For more than two devices, though, you must make new connections using a peripheral called a "hub." A hub, which you hook up directly to a USB connector on your computer, usually has 4 or 7 output connections enabling you to connect the same number of peripherals. One of the hub's main functions is to regenerate signals that lose part of their strength as they are transmitted via the USB cable. By connecting yet another hub to a connector on the existing hub, you can then plug in a new set of peripherals and so on, up to a maximum of 127.

Some hubs have no power supply and others are self-powered. When you choose a hub, opt for the self-powered variety, as they have their own AC adapter. The most powerful hubs provide 0.5A of power to each port.

If you buy a hub, make sure that it supports per-port switching. This function prevents the entire chain of peripherals from freezing up if one of them is not working properly or is down.

Will Hi-Speed USB 2.0 Devices Work On USB Hubs And Vice Versa?

You can use your Hi-Speed USB 2.0 devices with USB hubs, but the peripherals will be limited to USB performance levels. There are Hi-Speed USB 2.0 hubs that are able to communicate in three modes: high-speed (480Mb/s), full-speed (12Mb/s), and low-speed (1.5Mb/s). Hi-Speed USB 2.0 is backwards compatible, so you will be able to connect USB devices to Hi-Speed USB 2.0 hubs; however, the USB devices will still maintain their normal performance levels (i.e. 12 Mb/s).

In order to achieve the fast data transfer rates of Hi-Speed USB 2.0, you must connect your Hi-Speed USB 2.0 device directly to a Hi-Speed USB 2.0 port on either a computer or hub.



Tech Note:

- Avoid using USB connectors found on certain peripherals such as keyboards. These are passive (or pass-through) connectors that lead to power loss and unstable operation.
- Only use USB cables shorter than 5 meters (approximately 15 feet). Using longer cables may cause the peripherals to malfunction due to excessive reduction in electrical signal strength.

For more information about the USB interface, please visit:

www.lacie.com/technologies

8. Troubleshooting

In the event that your LaCie Big Disk Extreme with Triple Interface is not working correctly, please refer to the following checklist to find out where the problem is coming from. If you have gone through all of the points on the checklist and your drive is still not working correctly, please have a look at the FAQs that are regularly published on our Web site – www.lacie.com. One of these FAQs may provide an answer to your specific question. You can also visit the drivers pages, where the most recent software updates will be available.

If you need further assistance, please contact your LaCie reseller or LaCie Technical Support (see [9. Contacting Customer Service](#) for details).

Manual Updates

LaCie is constantly striving to give you the most up-to-date, comprehensive User's Manuals available on the market. It is our goal to provide you with a friendly, easy-to-use format that will help you quickly install and utilize the many functions of your new device.

If your manual does not reflect the configurations of the product that you purchased, please check our Web site for the most current version available.

These Troubleshooting tips are divided up by operating system:

[Mac Users – click here](#)

[Windows Users – click here](#)

8.1. Mac Users

The Problem	Questions to Ask	Possible Solutions
<p>The drive is not recognized by the computer.</p>	<p>Is there an icon for the drive appear on the desktop?</p>	<p>There should be an icon for the LaCie drive on the desktop. If the drive does not appear, follow the rest of the Troubleshooting tips to isolate the problem.</p>
	<p>Does your computer's configuration meet the minimum system requirements for use with this drive?</p>	<p>Check section 2.1. Minimum System Requirements – Mac Users for more information.</p>
	<p>Is the drive's power supply connected and turned on?</p>	<p>Make sure that the power supply is properly connected (see section 3.1. Connecting The Power Supply), that the drive has been turned on by pressing the On/Off button the front of the drive, and that the outlet the power supply is connected to is also turned on.</p>
	<p>Did you follow the correct installation steps for the specific interface and operating system.</p>	<p>Review the installation steps under 3.2. Connecting The Interface Cable – 3.2.1. Mac Users.</p>
	<p>Are both ends of the FireWire or USB cables firmly attached?</p>	<p>Check both ends of the FireWire or USB cables and make sure that they are fully seated in their respective ports. Try disconnecting the cables, waiting 10 seconds, and then reconnecting them. If the drive is still not recognized, restart your computer and try again.</p>
<p>The drive turns on and off when you turn your computer on and off.</p>	<p>This is normal. Your drive has an autoswitching power feature, which means that if your drive is connected to your computer, turning the computer on will automatically turn the drive on. Likewise, turning the computer off will automatically turn the drive off. If you wish to power off the drive while it is connected to your computer, first make sure that your computer is not accessing the drive and then follow the steps in section 3.5. Disconnecting Your LaCie Drive. After you have disconnected the drive, push the blue On/Off button on the front of the drive to turn the drive off.</p>	

The Problem	Questions to Ask	Possible Solutions
<p>The drive is not recognized by the computer.</p>	<p>Have the USB or FireWire drivers been installed correctly and enabled?</p>	<p>Mac Users: Open Apple System Profiler and click on the Devices and Volumes tab. If your device is not listed, recheck the cables and try the other troubleshooting tips listed here.</p>
	<p>Is there a conflict with other device drivers or extensions?</p>	<p>Contact LaCie Technical Support for help.</p>
	<p>Has the drive been formatted?</p>	<p>Make sure that the drive has been formatted properly. Please see sections 4.1. Formatting And Partitioning Your LaCie Drive and 5.1. File System Formats for more information.</p>
	<p>Does your computer's operating system support the file system?</p>	<p>Check your computer's documentation and see sections 4.1. Formatting And Partitioning Your LaCie Drive and 5.1. File System Formats for more information.</p>
<p>Error messages under Mac OS 10.x.</p>	<p>Did you get an "Error -50" message while copying to a FAT 32 volume?</p>	<p>When copying files or folders from Mac OS 10.x to a FAT 32 volume, certain characters cannot be copied. These characters include, but are not limited to: ? < > / \ : Check your files and folders to ensure that these types of characters are not being used.</p>
	<p>Did you get an error message telling you that the drive has been disconnected when coming out of sleep mode?</p>	<p>Simply ignore this message. The drive will remount to the desktop. LaCie drives conserve power by spinning down when you set your computer to sleep mode, and when the computer is "woken" from sleep, it does not give the drive enough time to spin-up from its sleep mode.</p>
	<p>Are you having problems getting your FireWire device to be recognized?</p>	<p>If you are having problems with your FireWire connection under Mac OS 10.2.x, upgrade to the latest version.</p>

The Problem	Questions to Ask	Possible Solutions
The drive is working slowly.	Are there other USB or FireWire devices connected to the same port or hub?	Disconnect any other USB or FireWire devices and see if the drive's performance increases.
The drive is not running noticeably faster when connected via Hi-Speed USB 2.0.	Are you operating in Mac OS 9.x?	Apple does not support the Hi-Speed USB 2.0 standard under Mac OS 9.x. You will be limited to the slower transfer rates of the original USB standard. For more information, please see 5.3.2. Hi-Speed USB 2.0 Ports And Performance .
	Are you operating in Mac OS 10.x?	Apple has only recently begun incorporating native Hi-Speed USB 2.0 ports in their computers. To achieve Hi-Speed USB 2.0 transfer rates, you will need to add a Hi-Speed USB 2.0 PCI or PC card to your computer. For more information, please see 5.3.2. Hi-Speed USB 2.0 Ports And Performance .
	Is the drive connected to a USB port on your computer, or to a USB hub?	If your drive is connected to a USB port or hub, this is normal. A Hi-Speed USB 2.0 device can only operate at Hi-Speed USB 2.0 performance levels when it is connected directly to a Hi-Speed USB 2.0 port or hub. Otherwise, the Hi-Speed USB 2.0 device will operate at the slower USB transfer rates. For more information, please see sections 5.3.2. Hi-Speed USB 2.0 Ports and Performance and 7. USB Questions And Answers .
	Is the drive connected to a Hi-Speed USB 2.0 port on your computer?	Check to see that the Hi-Speed USB 2.0 drivers for both your host bus adapter and device have been installed correctly. If in doubt, un-install the drivers and re-install them.
	Does your computer or operating system support Hi-Speed USB 2.0?	See sections 2.1. Minimum System Requirements – Mac Users and 5.3. Optimizing Data Transfers for more information.

8.2. Windows Users

The Problem	Questions to Ask	Possible Solutions
The drive is not recognized by the computer.	Has the drive been formatted?	Make sure that the drive has been formatted properly. Please see sections 4.1. Formatting And Partitioning Your LaCie Drive and 5.1. File System Formats for more information.
	Does your computer's operating system support the file system?	Check your computer's documentation and see sections 4.1. Formatting And Partitioning Your LaCie Drive and 5.1. File System Formats for more information.
	Is there an icon for the drive in My Computer ?	Go into My Computer and look for an icon and drive letter assigned to the LaCie drive. If the drive does not appear, follow the rest of the Troubleshooting tips to isolate the problem.
	Does your computer's configuration meet the minimum system requirements for use with this drive?	Check section 2.1. Minimum System Requirements – Windows Users for more information.
	Is the drive's power supply connected and turned on?	Make sure that the power supply is properly connected (see section 3.1. Connecting The Power Supply), that the drive has been turned on by pressing the On/Off button the front of the drive, and that the outlet the power supply is connected to is also turned on.
	Did you follow the correct installation steps for the specific interface and operating system.	Review the installation steps under 3.2. Connecting The Interface Cable – 3.2.2. Windows Users .
	Are both ends of the FireWire or USB cables firmly attached?	Check both ends of the FireWire or USB cables and make sure that they are fully seated in their respective ports. Try disconnecting the cables, waiting 10 seconds, and then reconnecting them. If the drive is still not recognized, restart your computer and try again.

The Problem	Questions to Ask	Possible Solutions
<p>The drive is not recognized by the computer.</p>	<p>Have the USB or FireWire drivers been installed correctly and enabled?</p>	<p>Windows 2000 Users: Go to Start > Settings > Control Panel > System > Hardware tab > Device Manager button > USB Controller or IEEE 1394 Controller. Click on the + sign next to the controller icon, and you should see your device listed.</p> <p>Windows XP Users: Go to Start > Control Panel > Performance and Maintenance > System > Hardware tab > Device Manager button > USB Controller or IEEE 1394 Controller. Click on the + sign next to the controller icon, and you should see your device listed.</p> <p>If you still can't see your device, recheck the cables and try the other troubleshooting tips listed here.</p>
<p>The drive turns on and off when you turn your computer on and off.</p>	<p>Is there a conflict with other device drivers or extensions?</p>	<p>Contact LaCie Technical Support for help.</p> <p>This is normal. Your drive has an autoswitching power feature, which means that if your drive is connected to your computer, turning the computer on will automatically turn the drive on. Likewise, turning the computer off will automatically turn the drive off. If you wish to power off the drive while it is connected to your computer, first make sure that your computer is not accessing the drive and then follow the steps in section 3.5. Disconnecting Your LaCie Drive. After you have disconnected the drive, push the blue On/Off button on the front of the drive to turn the drive off.</p>
<p>FireWire 800 does not work under Windows 2000.</p>	<p>Have you installed the Windows 2000 Service Pack 4?</p>	<p>In order to operate FireWire 800 devices under Windows 2000, the Service Pack 4 update must be installed. This is a free download offered on Microsoft's Web site.</p>
<p>The drive is working slowly.</p>	<p>Are there other USB or FireWire devices connected to the same port or hub?</p>	<p>Disconnect any other USB or FireWire devices and see if the drive's performance increases.</p>

The Problem	Questions to Ask	Possible Solutions
<p>The drive is not running noticeably faster when connected via Hi-Speed USB 2.0.</p>	<p>Is the drive connected to a USB port on your computer, or to a USB hub?</p>	<p>If your drive is connected to a USB port or hub, this is normal. A Hi-Speed USB 2.0 device can only operate at Hi-Speed USB 2.0 performance levels when it is connected directly to a Hi-Speed USB 2.0 port or hub. Otherwise, the Hi-Speed USB 2.0 device will operate at the slower USB transfer rates. For more information, please see sections 5.3.2. Hi-Speed USB 2.0 Ports and Performance and 7. USB Questions And Answers.</p>
	<p>Is the drive connected to a Hi-Speed USB 2.0 port on your computer?</p>	<p>Check to see that the Hi-Speed USB 2.0 drivers for both your host bus adapter and device have been installed correctly. If in doubt, un-install the drivers and re-install them.</p>
	<p>Does your computer or operating system support Hi-Speed USB 2.0?</p>	<p>See sections 2.1. Minimum System Requirements – Windows Users and 5.3. Optimizing Data Transfers for more information.</p>
	<p>Are you using a certified Hi-Speed USB 2.0 cable to connect your drive?</p>	<p>Ensure that the cable you are using has been properly certified. The Hi-Speed USB 2.0 cable that was shipped with your LaCie drive has been properly certified and tested to comply with USB standards.</p>
	<p>Are you using Windows 98 SE or Windows Me?</p>	<p>These systems are not supported; USB will not work with either Windows 98 SE or Windows Me.</p>

9. Contacting Customer Support

Before You Contact Technical Support

1) Read the manuals and review the [Troubleshooting](#) section.

2) Try to isolate the problem. If possible, make the drive the only external device on the CPU, and make sure that all of the cables are correctly and firmly attached.

If you have asked yourself all of the pertinent questions in the troubleshooting checklist, and you still can't get your LaCie drive to work properly, contact us via the provided Web link. Before contacting us, make sure that you are in front of your computer and that you have the following information on hand:

- Your LaCie drive's serial number
- Operating system(Mac OS or Windows) and version
- Computer brand and model
- Names of CD or DVD drives installed on your computer
- Amount of memory installed
- Names of any other devices installed on your computer

LaCie Technical Support

LaCie Asia

Contact Us At:

<http://www.lacie.com/asia/contact>

LaCie Belgium

Contact Us At:

<http://www.lacie.com/be/contact/>

LaCie Denmark

Contact Us At:

<http://www.lacie.com/dk/contact/>

LaCie France

Contact Us At:

<http://www.lacie.com/fr/contact/>

LaCie Italy

Contact Us At:

<http://www.lacie.com/it/contact/>

LaCie Netherlands

Contact Us At:

<http://www.lacie.com/nl/contact/>

LaCie Spain

Contact Us At:

<http://www.lacie.com/es/support/request>

LaCie Switzerland

Contact Us At:

<http://www.lacie.com/chfr/contact>

LaCie USA

Contact Us At:

<http://www.lacie.com/contact/>

LaCie Australia

Contact Us At:

<http://www.lacie.com/au/contact/>

LaCie Canada

Contact Us At:

<http://www.lacie.com/caen/contact/> (English)

LaCie Finland

Contact Us At:

<http://www.lacie.com/fi/contact>

LaCie Germany

Contact Us At:

<http://www.lacie.com/de/contact/>

LaCie Japan

Contact Us At:

<http://www.lacie.co.jp>

LaCie Norway

Contact Us At:

<http://www.lacie.com/no/contact/>

LaCie Sweden

Contact Us At:

<http://www.lacie.com/se/contact/>

LaCie United Kingdom & Ireland

Contact Us At:

<http://www.lacie.com/uk/support/request>

LaCie Grand Export

Contact Us At:

<http://www.lacie.com/intl/contact/>

10. Warranty

LaCie warrants your drive against any defect in material and workmanship, under normal use, for the period designated on your warranty certificate. In the event this product is found to be defective within the warranty period, LaCie will, at its option, repair or replace the defective drive.

This warranty is void if:

- The drive was operated/stored in abnormal use or maintenance conditions;
- The drive is repaired, modified or altered, unless such repair, modification or alteration is expressly authorized in writing by LaCie;
- The drive was subjected to abuse, neglect, lightning strike, electrical fault, improper packaging or accident;
- The drive was installed improperly;
- The serial number of the drive is defaced or missing;
- The broken part is a replacement part such as a pickup tray, etc.
- The tamper seal on the drive casing is broken.

LaCie and its suppliers accept no liability for any loss of data during the use of this device, or for any of the problems caused as a result.

LaCie will not, under any circumstances, be liable for direct, special or consequential damages such as, but not limited to, damage or loss of property or equipment, loss of profits or revenues, cost of replacement goods, or expense or inconvenience caused by service interruptions.

Any loss, corruption or destruction of data while using a LaCie drive is the sole responsibility of the user, and under no circumstances will LaCie be held liable for the recovery or restoration of this data.

Under no circumstances will any person be entitled to any sum greater than the purchase price paid for the drive.

To obtain warranty service, call LaCie Technical Support. You will be asked to provide your LaCie product's serial number, and you may be asked to furnish proof of purchase to confirm that the drive is still under warranty.

All drives returned to LaCie must be securely packaged in their original box and shipped with postage prepaid.



Important Info: Register online for free technical support: www.lacie.com/register

Glossary

Asynchronous – Data transfer method where the data is transferred independently of other processes. With this transfer method, the intervals between transmissions can vary, and data can be resent if it is initially missed.

Backup – (1) The act of creating at least one additional copy of data onto a different (and safe) storage device from where it can be retrieved at a later time if needed. (2) A copy of a file, directory, or volume on a separate storage device from the original, for the purposes of retrieval in case the original is erased, damaged, or destroyed.

Bit – The smallest measure of computerized data, either a 1 or a 0. Eight bits equal one byte, or one character.

Block – A very small section of the storage media comprised of one or more sectors. A block is the smallest amount of space allocated on a drive for data storage. By default, a sector of data consists of 512 bytes.

Buffer – RAM cache that is faster than the data that is being delivered. Buffers are used so data may be stored and delivered to the receiving item as it is needed.

Bus – Electronic links that enable data to flow between the processor, RAM and extension cables (peripherals).

Byte – A sequence of adjacent binary digits, or bits, considered as a unit, 8 bits in length. There are 8 bits in 1 byte. See also MB (Megabyte) or GB (Gigabyte).

Cache, -ing – This is an area of electronic storage (usually RAM) set aside to store frequently used data from electro-mechanical storage (hard drives, floppy disks, CD/DVD-ROM, tape cartridges, etc.) Therefore, storing frequently used data in RAM can enhance your system's overall response to disk-intensive operations significantly.

Configuration – When talking about a PC, configuration is understood to be the sum of the internal and external components of the system, including memory, disk drives, the keyboard, the video subsystem and other peripherals, such as the mouse, modem or printer. The configuration also implies software: the operating system and various device managers (drivers), as well as hardware settings and options set by the user via configuration files.

Controller – This is a component or an electronic card (referred to in this case as a "controller card," such as PCI or PCMCIA cards) that enables a computer to communicate with or manage certain peripherals. The controller manages the operation of the peripheral associated with it, and links the PC bus to the peripheral via a ribbon cable inside the PC. An external controller is an expansion card which fills one of the free slots inside your PC and which enables a peripheral (CD-ROM drive, scanner or printer, for instance) to be connected to the computer.

Cross-platform – Term that refers to a device that is able to be operated by both Mac and Windows operating systems.

Data Stream – The flow of data that accomplishes a task, usually related to moving data from storage to computer RAM or between storage devices.

Digital – Discrete information that can be broken down to zero or one bits.

Driver (peripheral manager) – A software component that enables the computer system to communicate with a peripheral. Most peripherals will not operate correctly – if at all – if the appropriate drivers are not installed on the system.

File System – Links the physical map of a disc to its logical structure. Thanks to the file system, users and computers can easily display path, directories and files recorded onto the disc.

Firmware – Permanent or semi-permanent instructions and data programmed directly into the circuitry of a programmable read-only memory or an electronically-erasable, programmable read-only memory chip. Used for controlling the operation of the computer or tape drive. Distinct from the software, which is stored in random access memory and can be altered.

Folder – A list created on a disk to store files. Creating folders and sub-folders enables you to organize the storage of your files in a logical, hierarchical manner so that you can find and manage them more easily.

Format, -ting, -ted – This is a process where a device is prepared to record data. In this process, the hard disk writes special information onto its own recording surfaces into areas (blocks) that are ready to accept user data. Since this operation causes all current user data stored on the hard disk to be lost, this is an infrequent operation that usually only happens at the factory that created the hard disk. It is unusual for something to happen to a hard disk that requires the end-user to initially perform this operation.

GB (GigaByte) – This value is normally associated with data storage capacity. Basically, it means a thousand million or a billion bytes. In fact, it equals 1,073,741,824 bytes (or 1,024 x 1,024 x 1,024).

Hardware – Physical components of a computer system, including the computer itself and peripherals such as printers, modems, mice, etc.

Host Bus Adapter (HBA) – A printed circuit board that installs in a standard microcomputer and an interface between the device controller and the computer. Also called a controller.

Initialize, -ed, Initialization – After a hard drive (or other storage device) is formatted and partitioned, some special data needs to be written to it that helps the Mac and Windows create files and save data. The process is called initialization. This process, like formatting, causes all user data on the storage device to be lost.

Interface – The protocol data transmitters, data receivers, logic and wiring that link one piece of computer equipment to another, such as a hard drive to an adapter or an adapter to a system bus. Protocol means a set of rules for operating the physical interface, such as: do not read or write before the drive is ready.

I/O (Input/Output) – Refers to an operation, program or device whose purpose is to enter data into or to extract data from a computer.

Isochronous – Data transfer method that ensures that data flows continuously and at a steady rate. These transfers provide guaranteed transmission opportunities at defined intervals.

Kb (Kilobit) – Equivalent to 1,000 bits.

Kb/s – Kilobits per second. 480Kb/s is equal to 60KB/s.

KB (KiloByte) – Basically, this means 1,000 bytes, but it is actually 1,024 bytes.

KB/s – Kilobytes per second. A means of measuring throughput.

Mb (Megabit) – Equivalent to 1,000,000 bits.

Mb/s – Megabits per second. A means of measuring throughput. 480Mb/s is equal to 60MB/s.

MB (Megabyte) – Basically means one million bytes, but is actually 1,024 Kilobytes or 1,024 x 1,024 bytes, which equals 1,048,576 bytes.

MB/s – Megabytes per second. A means of measuring throughput.

Media – The material or device used to store information in a storage subsystem, such as a tape cartridge, CD, DVD or disk drive.

Operating System (OS) – Software that controls the assignment and use of hardware resources such as memory, processor time, disk space and peripherals. An operating system is the basis on which software (applications) run. Windows, Mac OS and UNIX are among the most common.

Overwrite – To write data on top of existing data thus erasing the original data.

Partition, -ing – After formatting, the hard drive is not yet ready to store files. It must be divided into sections that will contain special information required for a Mac or PC to operate and other sections that will contain the files. This process of dividing up the hard drive is called partitioning. A partition is just one section of the hard drive that will contain either special data put there by Silverlining or other files and data.

Peripheral – A generic term applied to printers, scanners, mice, keyboards, serial ports, graphics cords, disk drives and other computer subsystems. This type of peripheral often relies on its own control software, known as a peripheral driver.

Port, hardware – A connection component (SCSI port, for example) that enables a microprocessor to communicate with a compatible peripheral.

Port, software – A memory address that identifies the physical circuit used to transfer information between a microprocessor and a peripheral.

RAM (Random Access Memory) – Generally referred to as a computer's "memory." An integrated circuit memory chip that allows information to be stored and retrieved by a microprocessor or controller. The information can be stored or accessed in any order, and all storage locations are equally accessible.

Seek Time – The amount of time (in thousandths of a second, or milliseconds) that it takes a hard drive's read/write head to move to a specific location on the disk. Average seek, then, is the average of a large number of random samplings all over the disk. Seek time is CPU independent, meaning that seek time is the same for a disk drive, whether it is attached to a computer or not.

Software – In a nutshell, software is a set of instructions for the computer. A set of instructions to perform a particular task is called a program. There are two main types of software: system software (an operating system such as Mac OS or Windows) which controls the operation of the computer and application software (programs such as Word or Excel) which enable users to perform tasks such as word processing, spreadsheet creation, graphics, etc.

Storage – In computers, any equipment in which information may be kept. PCs generally use disk units and other external storage media (diskettes, CD-ROMs, magnetic disks, etc.) for permanent storage of information.

Striping – Spreading data evenly over multiple disk drives to enhance performance. Data striping can be performed on a bit, byte or block basis for optimum application performance.

Transfer Rate – The rate at which the drive sends and receives data from the controller. Transfer rates for reading data from the disk drive may not be the same as the transfer rate for writing data to the disk drive. Transfer rates are CPU dependent, meaning that regardless of how great a transfer rate your drive is capable of, the actual transfer rate can only be as fast as the slowest of your hard drive and computer.

Volume – A desktop mountable storage area, may be a partition of a hard drive, a removable disk or a cartridge. Typically measured in Megabytes or Gigabytes.

Utility – Software designed to perform maintenance tasks on the system or its components. Examples include backup programs, programs to retrieve files and data on disk, programs for preparing (or formatting) a disk or and resource editors.