

**LACIE** QUICK INSTALL GUIDE

# 2big NAS

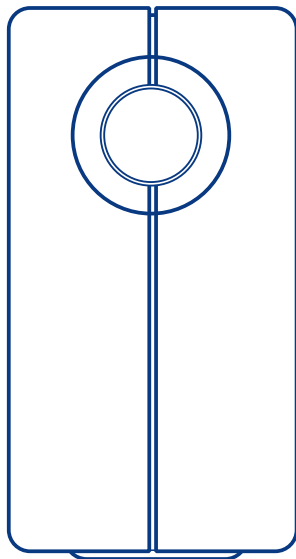

DESIGN BY NEIL POULTON

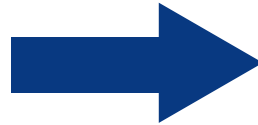
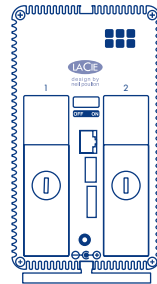
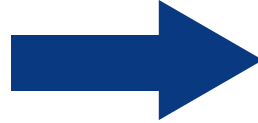

1

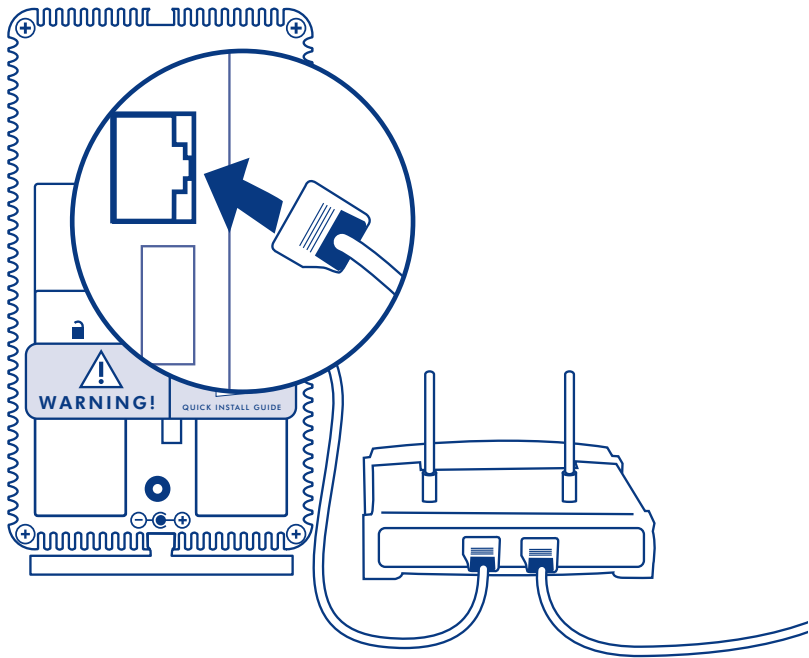

1

2

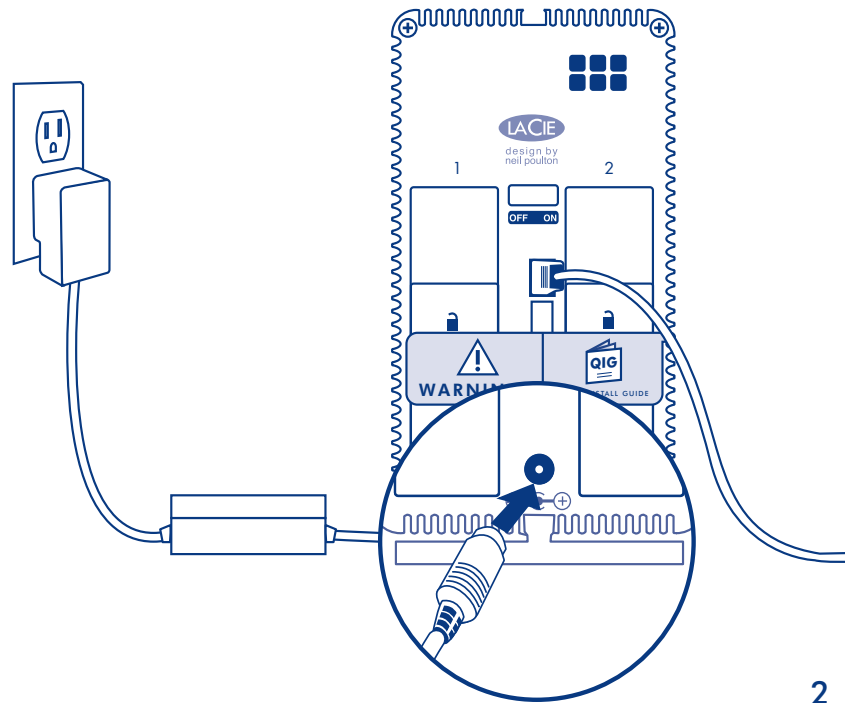

2

3

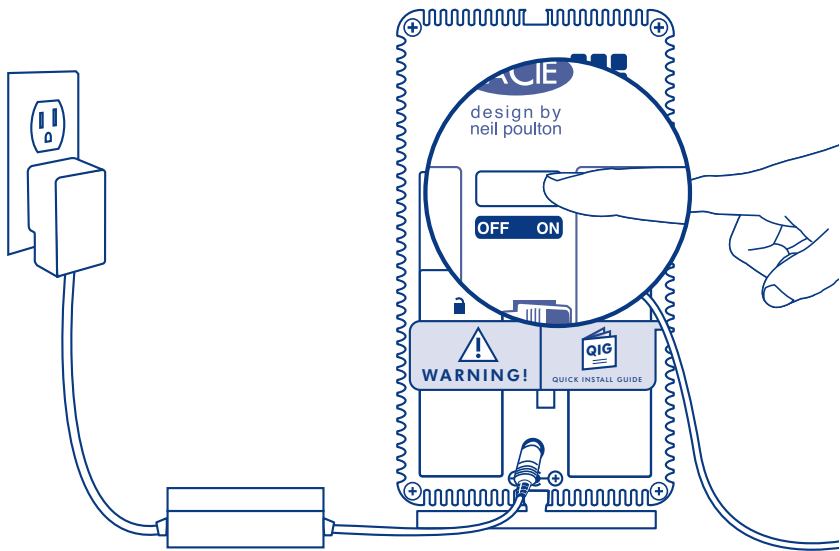

3

4

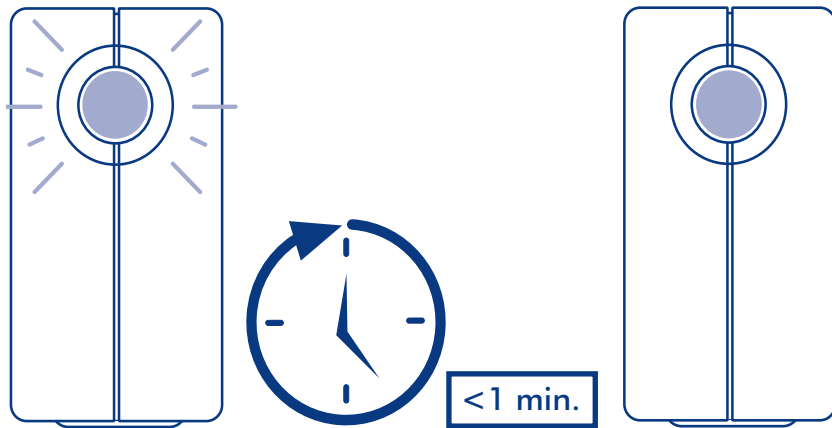

4

5

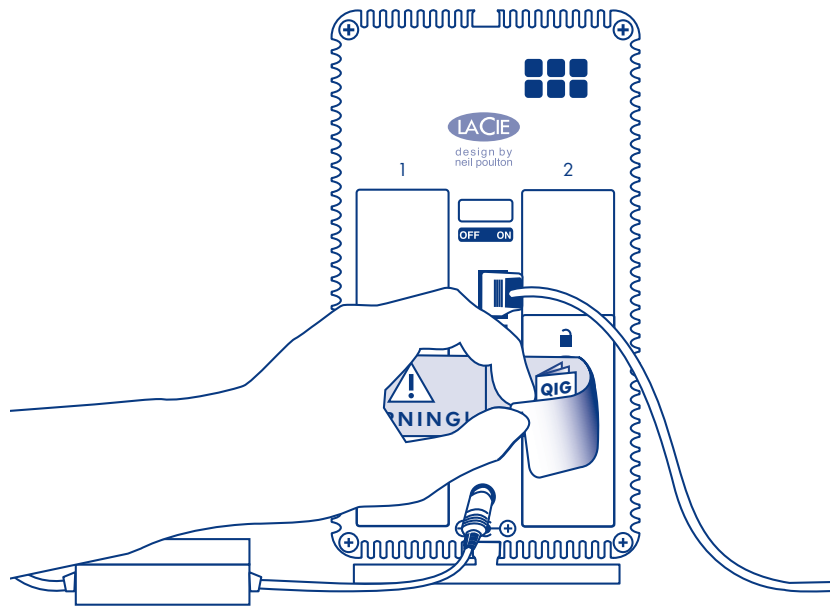

5

6

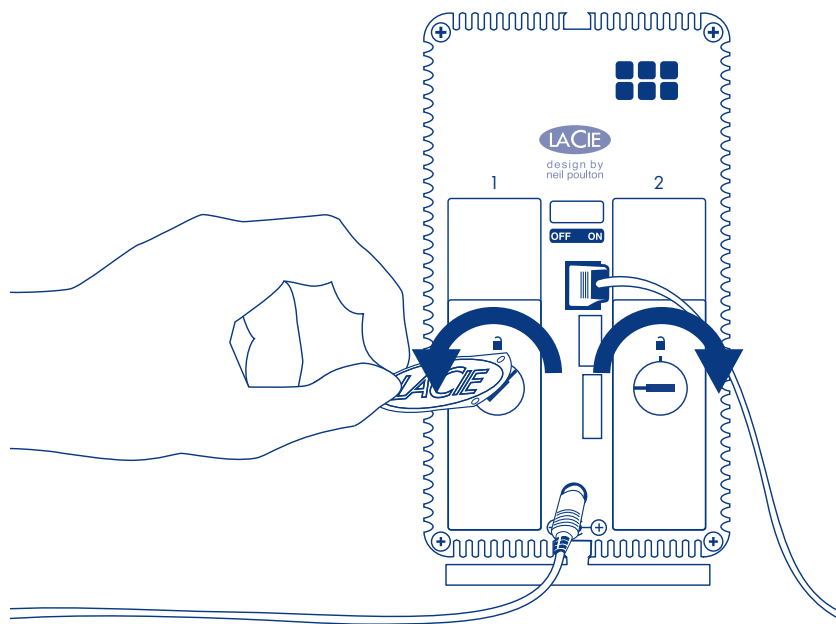

6

7

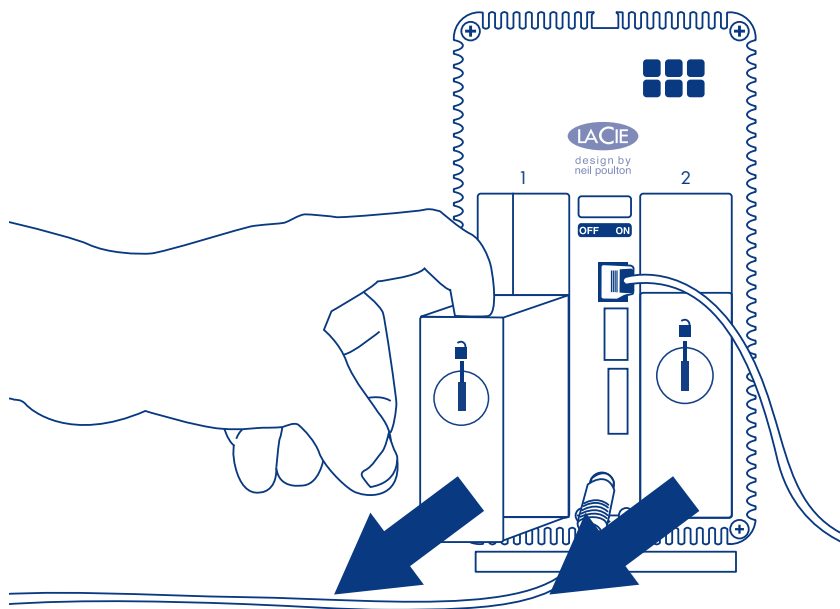

7

8

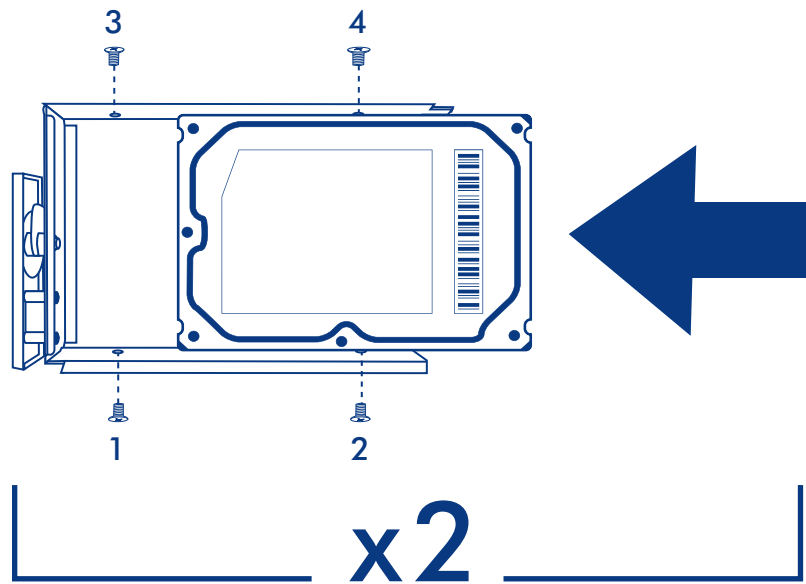

8

9

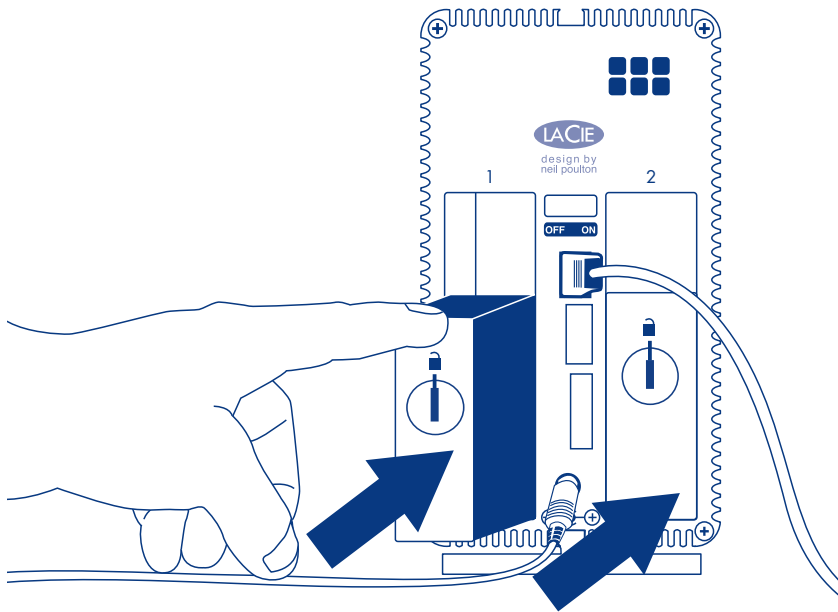

9

10

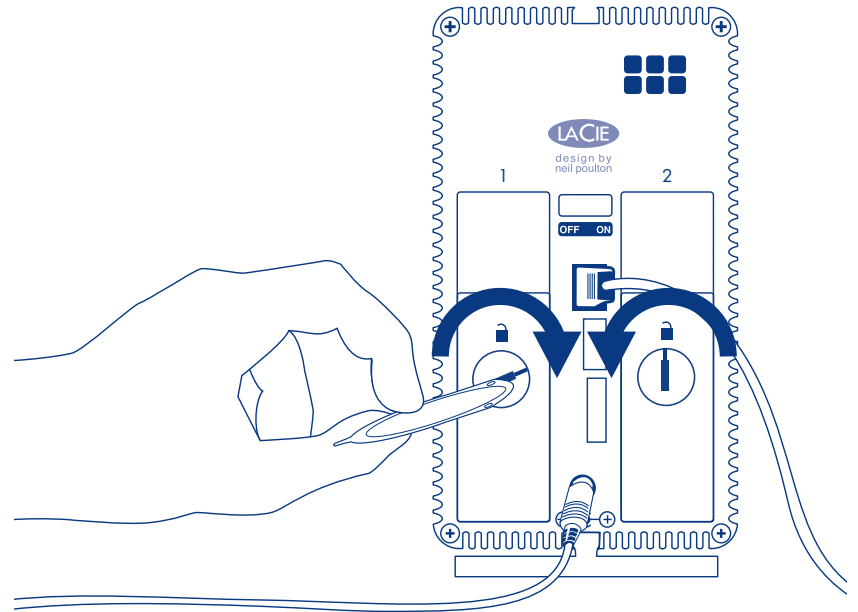

10

11



< 1 min.

12

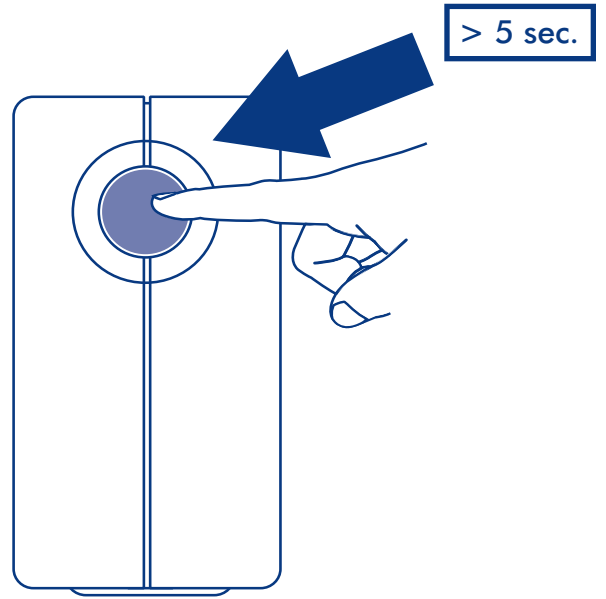



13

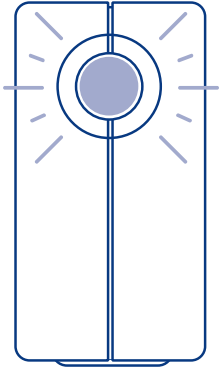
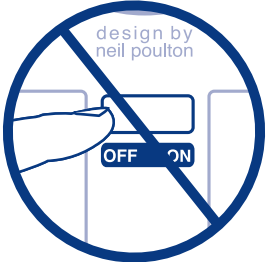

10 - 16 min.

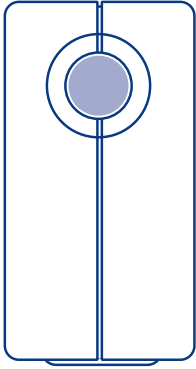

14

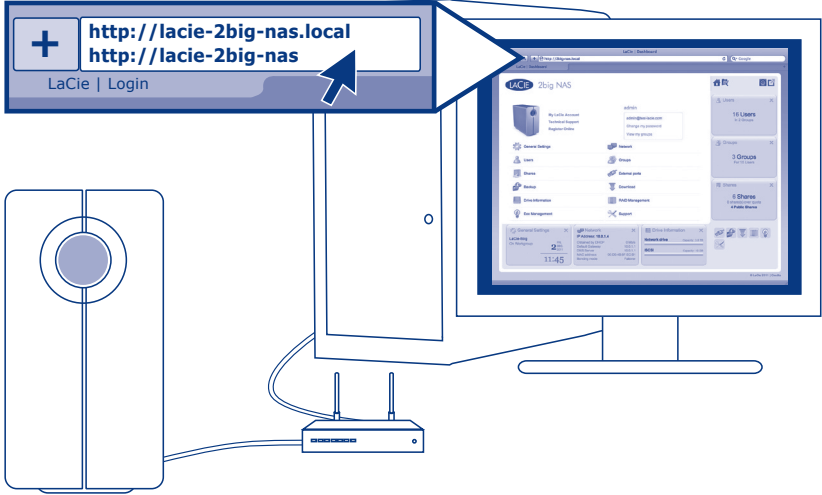



[manuals.lacie.com/2big-nas](https://manuals.lacie.com/2big-nas)

---



[www.lacie.com/register](https://www.lacie.com/register)

---



[www.lacie.com/products/warranty](https://www.lacie.com/products/warranty)

---



[www.lacie.com/support](https://www.lacie.com/support)

---



[www.lacie.com/contact](https://www.lacie.com/contact)

---



[www.lacie.com](https://www.lacie.com)

1

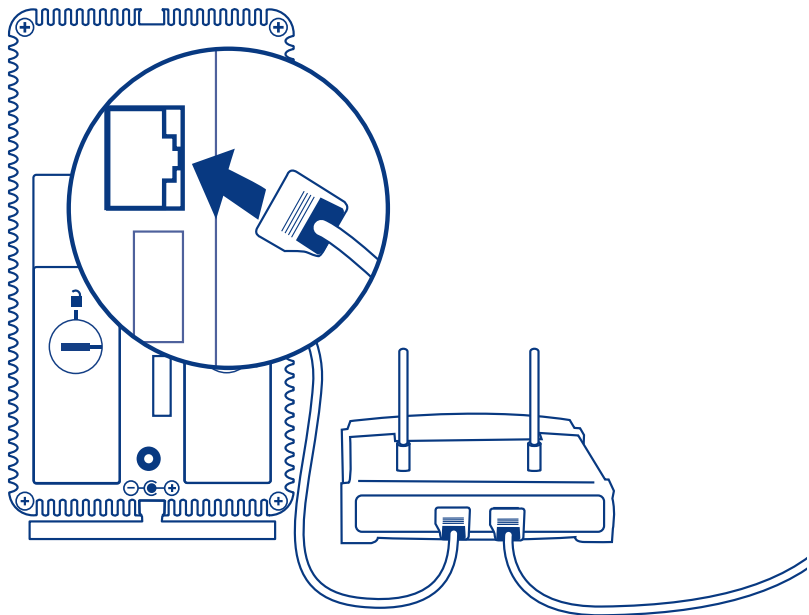

17

2

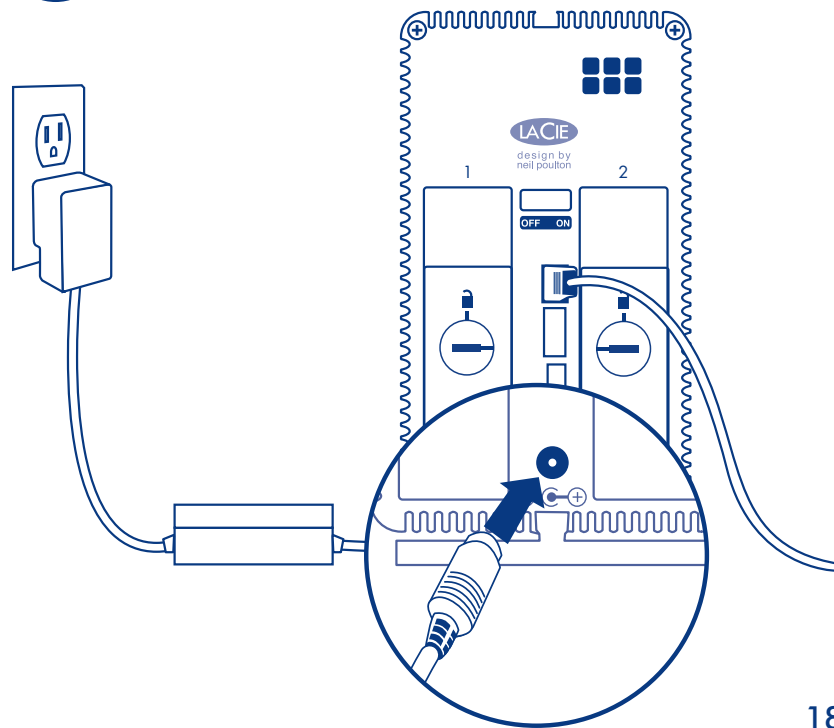

18

3

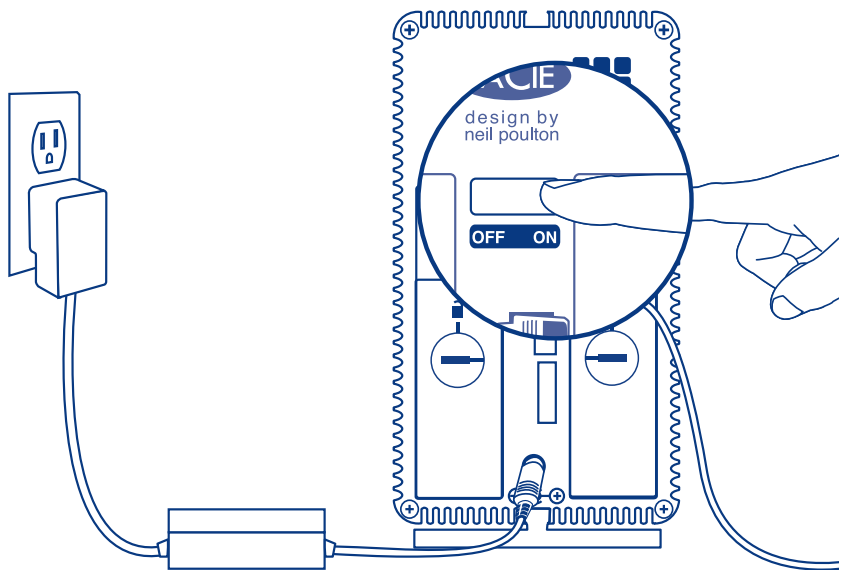

4

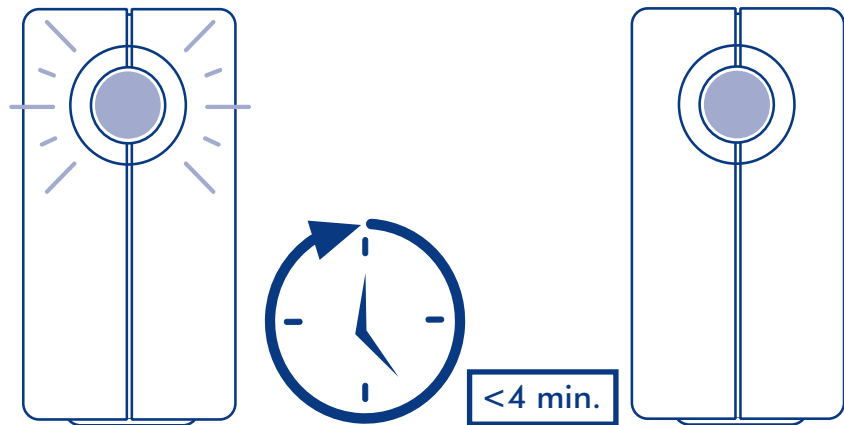

5

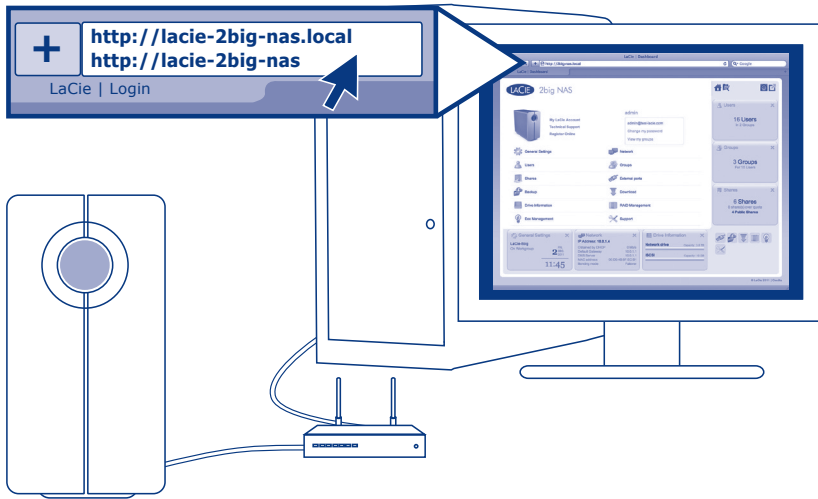

[manuals.lacie.com/2big-nas](http://manuals.lacie.com/2big-nas)



[www.lacie.com/register](http://www.lacie.com/register)



[www.lacie.com/products/warranty](http://www.lacie.com/products/warranty)



[www.lacie.com/support](http://www.lacie.com/support)



[www.lacie.com/contact](http://www.lacie.com/contact)



[www.lacie.com](http://www.lacie.com)



100% Recyclable

Copyright © 2012, LaCie 120327