

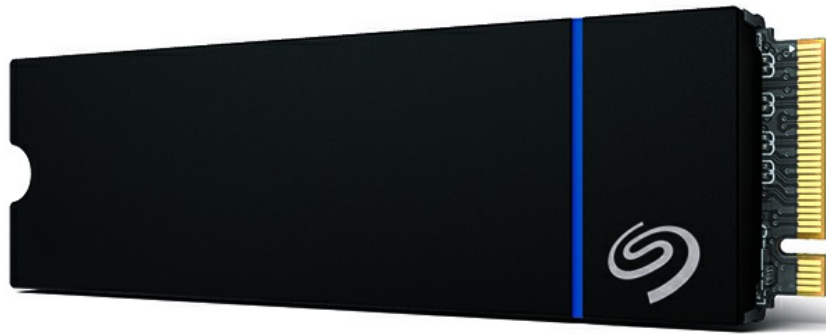

Game Drive M.2 Installation Guide



Model: PCIe Gen4 NVMe™ SSD + Heatsink



Click here to access an up-to-date online version of this document. You will also find the most recent content as well as expandable illustrations, easier navigation, and search capability.

Contents

1	Introduction	3
	Product information	3
	Before installing	3
	Equipment	3
2	Installing Game Drive M.2	4
	Step 1 - Turn off your console	4
	Step 2 - Remove the console cover	4
	Step 3 - Remove expansion slot cover	4
	Step 4 - Remove SSD screw	5
	Step 5 - Insert Game Drive M.2	5
	Step 6 - Fasten Game Drive M.2	6
	Step 7 - Attach expansion slot cover	6
	Step 8 - Replace console cover	6
	Step 9 - Reconnect	7
3	Support & Services	8
	Online support and services	8
	Warranty support	8

Introduction

Product information

- Intended for PlayStation 5 consoles.
- Game Drive M.2's heatsink is pre-installed. Removing it may damage Game Drive M.2.
- Dimensions of Game Drive M.2 are 80.15 mm (L) x 24.20 mm (W) x 9.50 mm (H). Verify that your system provides enough space for installation.
- M.2 connectors H3.2 and above are recommended for an SSD with a heatsink.

Before installing

- Make sure your system software is up to date.
- Press and hold the power button for three seconds to turn off your PS5 console.
- Remove all cables and devices from your PS5 console and wait for it to cool down.
- Touch a metal-grounded object to remove any static electricity from your body. Failure to do so may damage Game Drive M.2 or your PS5 console.
- Do not power on or play on your console while the cover is off.



If you have not used Game Drive M.2 before, you will need to format it after completing the installation. Formatting Game Drive M.2 will erase any saved data on the drive. Make sure you've backed up any important data on the drive before installing.

Equipment

To install Game Drive M.2, you will need:

- A well-lit room with a clean table to work on.
- A No. 1 Phillips (cross-head) screwdriver.
- A small torch (optional)

Installing Game Drive M.2

Step 1 - Turn off your console

Remove all cables and devices connected to your console. Wait a while for your console to cool down.

Place your console on a flat surface with a clean protective covering. Remove the base and position the console so that the logo is facing down, with the power button facing away from you.

Step 2 - Remove the console cover

Grip the bottom-right and top-left corners of the cover.

- A. Gently lift the right side of the cover.
- B. Slide the cover off to the left.

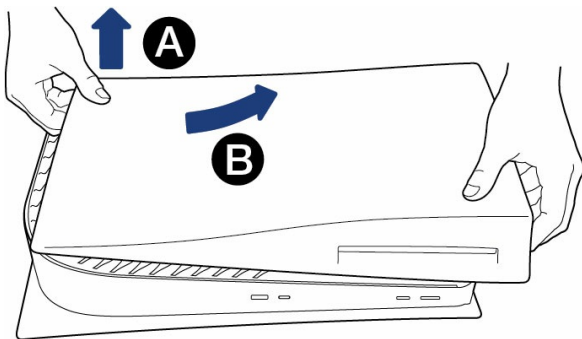

Step 3 - Remove expansion slot cover

Locate the rectangular expansion slot cover. Remove the screw, and then remove the cover.

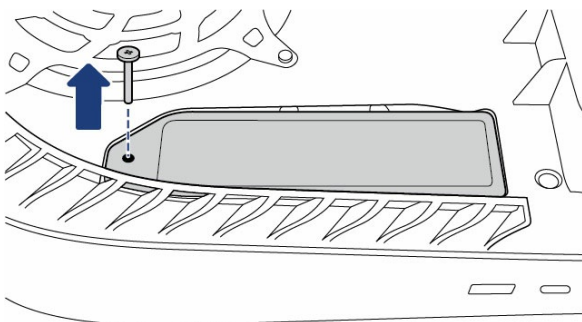

Step 4 - Remove SSD screw

Carefully remove the SSD screw in the slot and lift up the spacer.

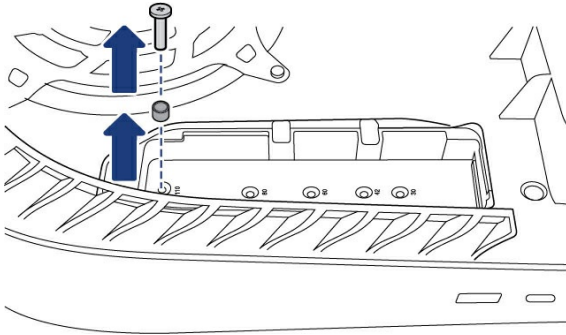

Move the spacer to the groove marked "80".

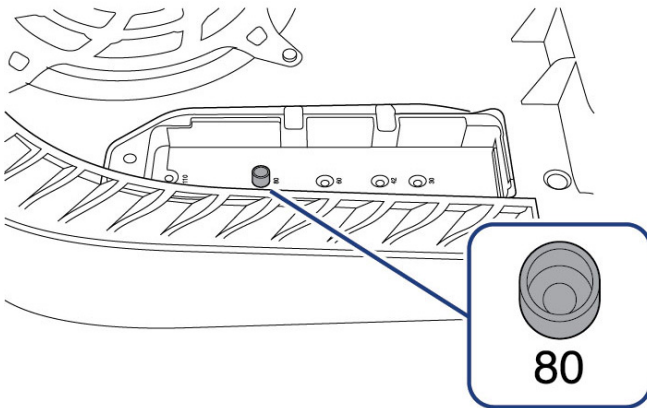

Step 5 - Insert Game Drive M.2

Carefully insert Game Drive M.2 into the expansion connector until it is firmly seated in the slot.

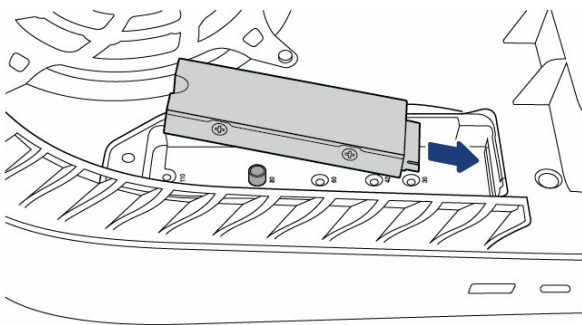

! **Important** Make sure Game Drive M.2 is inserted all the way into the expansion connector before proceeding to the next step. If Game Drive M.2 is incorrectly inserted, it may cause damage to the terminal and your console.

Step 6 - Fasten Game Drive M.2

Ensure that Game Drive M.2 is flush with the spacer. Fasten Game Drive M.2 to the spacer with the SSD screw.

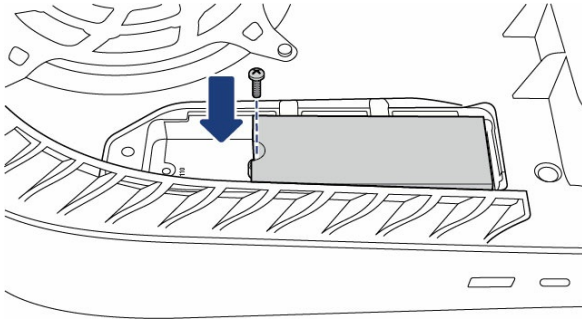

Step 7 - Attach expansion slot cover

Attach the expansion slot cover and fasten the screw.

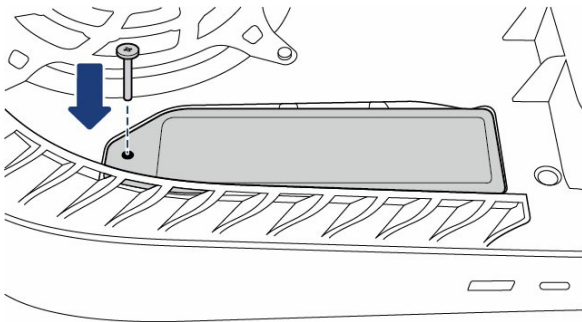

Step 8 - Replace console cover

Position the cover slightly away from the top edge of the console and slide it back into place. You'll hear a click when the cover is secured.

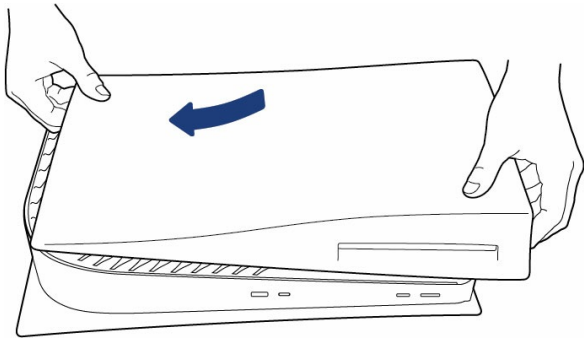

Step 9 - Reconnect

Reattach the base and connect the AC power cord and cables.

Turn on the power. If your Game Drive M.2 has never been used on a console, you should see instructions for formatting it.

Support & Services

Online support and services

Go to www.seagate.com/contacts.

Warranty support

Go to www.seagate.com/support/warranty-and-replacements.